



# SERVICE MANUAL ADDENDUM--A-02-06.01

NOTE: This addendum has been issued to be included with *Service Manual LN-9244-03, RMA-202 Robot Mounted Rotary Atomizer.*

## Break-Away Feature

The RMA-202 assembly is equipped with a break-away feature to minimize the damage to the atomizer, robot, etc. If a collision occurs, the six (6) plastic break-away screws fail and the atomizer will break free. This will leave the break-away ring and the mounting ring attached to the robot. A tether will be activated which is connected to the atomizer and the break-away ring, preventing the atomizer from failing. This feature can be disabled by replacing the six (6) break-away screws with six (6), glass filled nylon, 1/4-20 X 1/2" long, fillister head screws (LSFA-0004-16F).

<b>SERVICE KIT &amp; ACCESSORY OPTIONS</b>	
<b>Part #</b>	<b>Description</b>
AER4019	Air Bearing Rebuild Kit
LSFA-0004-16C	Screw, 1/4-20 X 1/2" Long, Fillister Head, Glass Filled Nylon 
A10568-XX	Teach Bracket Kit

 Used as replacement screw option for 77524-00 break-away screws  
(Tighten 3-5 lbs•in)

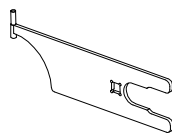

RPM-419  
SHROUD/BELL CUP WRENCH  
(OPTIONAL)

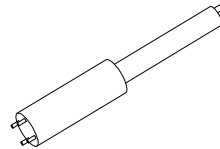

78985-00  
VALVE TOOL  
(SUPPLIED WITH ATOMIZER)

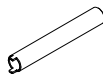

78279-00  
FIBER OPTIC TOOL  
(SUPPLIED WITH ATOMIZER)

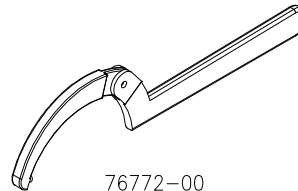

76772-00  
ADJUSTABLE SPANNER WRENCH  
(OPTIONAL)

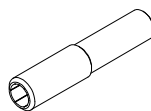

78982-00  
FLUID TIP TOOL  
(SUPPLIED WITH ATOMIZER)

# RMA-202 Rotary Atomizer - Addendum

<b>ROBOT ADAPTER (Not Included With Kit)</b>	
<b>Part #</b>	<b>Description</b>
A10568-01	For Use With 30mm Bell Cup Atomizer
A10568-02	For Use With 57 & 57 "V" Bell Cup Atomizers

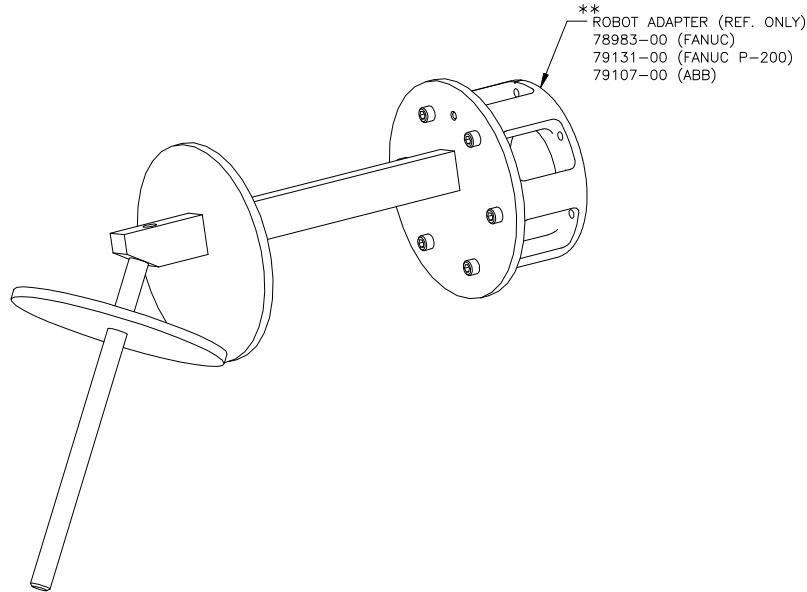

\*\* Robot adapter not included with Kit.

---

## Manufacturing

1910 North Wayne Street  
 Angola, Indiana 46703-9100  
 Telephone: 260/665-8800  
 Fax: 260/665-8516

## Technical/Service Assistance

Automotive Assembly and Tier I  
 Industrial Systems  
 Ransburg Guns

Telephone: 800/ 626-3565    Fax: 419/ 470-2040  
 Telephone: 800/ 233-3366    Fax: 419/ 470-2071  
 Telephone: 800/ 233-3366    Fax: 419/ 470-2071

Technical Support Representative will direct you to the appropriate telephone number for ordering Spare Parts.