

RF-1 FLOWMETER

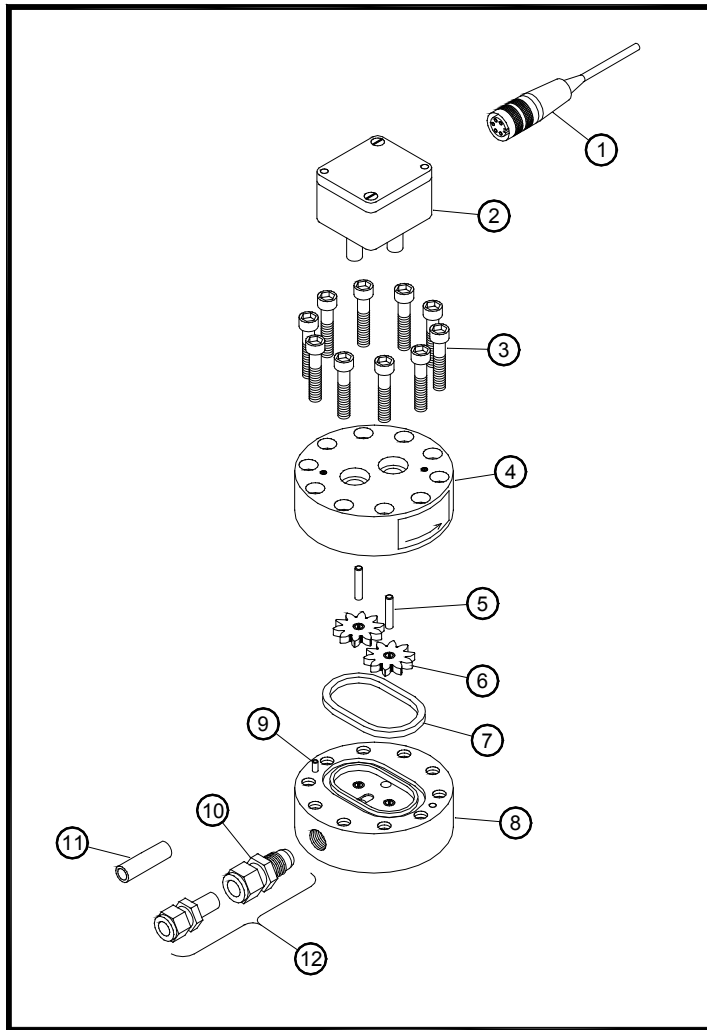

(76251-01)

IMPORTANT: Before using this equipment, carefully read **SAFETY PRECAUTIONS**, starting on page 1, and all instructions in this manual. Keep this Service Manual for future reference.

NOTE: This service manual has been superceded from service manual number **FM-00-01.3** to service manual number **FM-00-01.4**. Reasons for this change are noted under "Manual Change Summary" inside the back cover of this manual.

CONTENTS

	PAGE
SAFETY:	1-5
SAFETY PRECAUTIONS.....	1
HAZARDS / SAFEGUARDS.....	2-5
INTRODUCTION:	6-8
DESCRIPTIONS.....	6
FLOW RATE ACCURACY.....	6
REVERSE FLOW DETECTION.....	6
FLUID PASSAGES.....	6
SPECIFICATIONS.....	6
INSTALLATION:	7
INSTALLATION.....	7
MAINTENANCE:	8-9
FLOWMETER SERVICING.....	8
SERVICE.....	8
CALIBRATION.....	9
AUTOMATIC CLEANING OF THE FLOWMETER.....	9
PARTS IDENTIFICATION:	10-11
RF-1 FLOWMETER / PARTS LIST.....	10-11
WARRANTY POLICIES:	12
LIMITED WARRANTIES.....	12

SAFETY

SAFETY PRECAUTIONS

Before operating, maintaining or servicing any Ransburg electrostatic coating system, read and understand all of the technical and safety literature for your Ransburg products. This manual contains information that is important for you to know and understand. This information relates to USER SAFETY and PREVENTING EQUIPMENT PROBLEMS. To help you recognize this information, we use the following symbols. Please pay particular attention to these sections.

A WARNING! states information to alert you to a situation that might cause serious injury if instructions are not followed.

A CAUTION! states information that tells how to prevent damage to equipment or how to avoid a situation that might cause minor injury.

A NOTE is information relevant to the procedure in progress.

While this manual lists standard specifications and service procedures, some minor deviations may be found between this literature and your equipment. Differences in local codes and plant requirements, material delivery requirements, etc., make such variations inevitable. Compare this manual with your system installation drawings and appropriate Ransburg equipment manuals to reconcile such differences.

Careful study and continued use of this manual will provide a better understanding of the equipment and process, resulting in more efficient operation, longer trouble-free service and faster, easier troubleshooting. If you do not have the manuals and safety literature for your Ransburg system, contact your local Ransburg representative or Ransburg.



WARNING



- The user **MUST** read and be familiar with the Safety Section in this manual and the Ransburg safety literature therein identified.
- This manual **MUST** be read and thoroughly understood by **ALL** personnel who operate, clean or maintain this equipment! Special care should be taken to ensure that the **WARNINGS** and safety requirements for operating and servicing the equipment are followed. The user should be aware of and adhere to ALL local building and fire codes and ordinances as well as **NFPA-33 SAFETY STANDARD, LATEST EDITION**, prior to installing, operating, and/or servicing this equipment.







WARNING

- The hazards shown on the following pages may occur during the normal use of this equipment. Please read the hazard chart beginning on page 2.

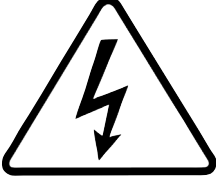
AREA Tells where hazards may occur.	HAZARD Tells what the hazard is.	SAFEGUARDS Tells how to avoid the hazard.
<p>Spray Area</p> 	<p>Fire Hazard</p> <p>Improper or inadequate operation and maintenance procedures will cause a fire hazard.</p> <p>Protection against inadvertent arcing that is capable of causing fire or explosion is lost if any safety interlocks are disabled during operation. Frequent Power Supply or Controller shutdown indicates a problem in the system requiring correction.</p>	<p>Fire extinguishing equipment must be present in the spray area and tested periodically.</p> <p>Spray areas must be kept clean to prevent the accumulation of combustible residues.</p> <p>Smoking must never be allowed in the spray area.</p> <p>The high voltage supplied to the atomizer must be turned off prior to cleaning, flushing or maintenance.</p> <p>When using solvents for cleaning:</p> <ul style="list-style-type: none"> • Those used for equipment flushing should have flash points equal to or higher than those of the coating material. • Those used for general cleaning must have flash points above 100°F (37.8°C). <p>Spray booth ventilation must be kept at the rates required by NFPA-33, OSHA, country, and local codes. In addition, ventilation must be maintained during cleaning operations using flammable or combustible solvents.</p> <p>Electrostatic arcing must be prevented. Safe sparking distance must be maintained between the parts being coated and the applicator. A distance of 1 inch for every 10KV of output voltage is required at all times.</p> <p>Test only in areas free of combustible material. Testing may require high voltage to be on, but only as instructed.</p> <p>Non-factory replacement parts or unauthorized equipment modifications may cause fire or injury.</p> <p>If used, the key switch bypass is intended for use only during setup operations. Production should never be done with safety interlocks disabled.</p> <p>Never use equipment intended for use in waterborne installations to spray solvent based materials.</p> <p>The paint process and equipment should be set up and operated in accordance with NFPA-33, NEC, OSHA, local, country, and European Health and Safety Norms.</p>

<p>AREA Tells where hazards may occur.</p>	<p>HAZARD Tells what the hazard is.</p>	<p>SAFEGUARDS Tells how to avoid the hazard.</p>
<p>Spray Area</p> 	<p>Explosion Hazard</p> <p>Improper or inadequate operation and maintenance procedures will cause a fire hazard.</p> <p>Protection against inadvertent arcing that is capable of causing fire or explosion is lost if any safety interlocks are disabled during operation.</p> <p>Frequent Power Supply or Controller shutdown indicates a problem in the system requiring correction.</p>	<p>Electrostatic arcing must be prevented. Safe sparking distance must be maintained between the parts being coated and the applicator. A distance of 1 inch for every 10KV of output voltage is required at all times.</p> <p>Unless specifically approved for use in hazardous locations, all electrical equipment must be located outside Class I or II, Division 1 or 2 hazardous areas, in accordance with NFPA-33.</p> <p>Test only in areas free of flammable or combustible materials.</p> <p>The current overload sensitivity (if equipped) MUST be set as described in the corresponding section of the equipment manual. Protection against inadvertent arcing that is capable of causing fire or explosion is lost if the current overload sensitivity is not properly set. Frequent power supply shutdown indicates a problem in the system which requires correction.</p> <p>Always turn the control panel power off prior to flushing, cleaning, or working on spray system equipment.</p> <p>Before turning high voltage on, make sure no objects are within the safe sparking distance.</p> <p>Ensure that the control panel is interlocked with the ventilation system and conveyor in accordance with NFPA-33, EN 50176.</p> <p>Have fire extinguishing equipment readily available and tested periodically.</p>
<p>General Use and Maintenance</p> 	<p>Improper operation or maintenance may create a hazard.</p> <p>Personnel must be properly trained in the use of this equipment.</p>	<p>Personnel must be given training in accordance with the requirements of NFPA-33, EN 60079-0.</p> <p>Instructions and safety precautions must be read and understood prior to using this equipment.</p> <p>Comply with appropriate local, state, and national codes governing ventilation, fire protection, operation maintenance, and housekeeping. Reference OSHA, NFPA-33, EN Norms and your insurance company requirements.</p>

<p>AREA Tells where hazards may occur.</p>	<p>HAZARD Tells what the hazard is.</p>	<p>SAFEGUARDS Tells how to avoid the hazard.</p>
<p>Spray Area / High Voltage Equipment</p> 	<p>Electrical Discharge</p> <p>There is a high voltage device that can induce an electrical charge on ungrounded objects which is capable of igniting coating materials.</p> <p>Inadequate grounding will cause a spark hazard. A spark can ignite many coating materials and cause a fire or explosion.</p>	<p>Parts being sprayed and operators in the spray area must be properly grounded.</p> <p>Parts being sprayed must be supported on conveyors or hangers that are properly grounded. The resistance between the part and earth ground must not exceed 1 meg ohm. (Refer to NFPA-33.)</p> <p>Operators must be grounded. Rubber soled insulating shoes should not be worn. Grounding straps on wrists or legs may be used to assure adequate ground contact.</p> <p>Operators must not be wearing or carrying any ungrounded metal objects.</p> <p>When using an electrostatic handgun, operators must assure contact with the handle of the applicator via conductive gloves or gloves with the palm section cut out.</p> <p>NOTE: REFER TO NFPA-33 OR SPECIFIC COUNTRY SAFETY CODES REGARDING PROPER OPERATOR GROUNDING.</p> <p>All electrically conductive objects in the spray area, with the exception of those objects required by the process to be at high voltage, must be grounded. Grounded conductive flooring must be provided in the spray area.</p> <p>Always turn off the power supply prior to flushing, cleaning, or working on spray system equipment.</p> <p>Unless specifically approved for use in hazardous locations, all electrical equipment must be located outside Class I or II, Division 1 or 2 hazardous areas, in accordance with NFPA-33.</p>

<p>AREA Tells where hazards may occur.</p>	<p>HAZARD Tells what the hazard is.</p>	<p>SAFEGUARDS Tells how to avoid the hazard.</p>
<p>Electrical Equipment</p> 	<p>Electrical Discharge</p> <p>High voltage equipment is utilized in the process. Arcing in the vicinity of flammable or combustible materials may occur. Personnel are exposed to high voltage during operation and maintenance.</p> <p>Protection against inadvertent arcing that may cause a fire or explosion is lost if safety circuits are disabled during operation.</p> <p>Frequent power supply shut-down indicates a problem in the system which requires correction.</p> <p>An electrical arc can ignite coating materials and cause a fire or explosion.</p>	<p>Unless specifically approved for use in hazardous locations, the power supply, control cabinet, and all other electrical equipment must be located outside Class I or II, Division 1 and 2 hazardous areas in accordance with NFPA-33 and EN 50176.</p> <p>Turn the power supply OFF before working on the equipment.</p> <p>Test only in areas free of flammable or combustible material.</p> <p>Testing may require high voltage to be on, but only as instructed.</p> <p>Production should never be done with the safety circuits disabled.</p> <p>Before turning the high voltage on, make sure no objects are within the sparking distance.</p>
<p>Toxic Substances</p> 	<p>Certain material may be harmful if inhaled, or if there is contact with the skin.</p>	<p>Follow the requirements of the Material Safety Data Sheet supplied by coating material manufacturer.</p> <p>Adequate exhaust must be provided to keep the air free of accumulations of toxic materials.</p> <p>Use a mask or respirator whenever there is a chance of inhaling sprayed materials. The mask must be compatible with the material being sprayed and its concentration. Equipment must be as prescribed by an industrial hygienist or safety expert, and be NIOSH approved.</p>
<p>Spray Area</p> 	<p>Explosion Hazard – Incompatible Materials</p> <p>Halogenated hydrocarbon solvents for example: methylene chloride and 1,1,1,-Trichloroethane are not chemically compatible with the aluminum that might be used in many system components. The chemical reaction caused by these solvents reacting with aluminum can become violent and lead to an equipment explosion.</p>	<p>Aluminum is widely used in other spray application equipment - such as material pumps, regulators, triggering valves, etc. Halogenated hydrocarbon solvents must never be used with aluminum equipment during spraying, flushing, or cleaning. Read the label or data sheet for the material you intend to spray. If in doubt as to whether or not a coating or cleaning material is compatible, contact your coating supplier. Any other type of solvent may be used with aluminum equipment.</p>

INTRODUCTION

DESCRIPTIONS

The **RF-1 Flowmeter** has been developed for precise metering and monitoring of fluid flows. The flowmeter in many cases, surpasses the performance of meters currently used.

FLOW RATE ACCURACY

Flow rate accuracies of 0.5% are not uncommon with many fluids if the flowmeters are calibrated at or near the expected flow rates. Even with wide flow rate swings (such as when used with robots under analog control) accuracies of +/- 2% are achievable.

REVERSE FLOW DETECTION

Sensors are of the quadrature type, which allows reverse flow detection, if necessary. Under conditions where reverse flow detection is not necessary, only one sensor output is used, leaving the second sensor output as a spare output that can be used if the first sensor should ever fail.

FLUID PASSAGES

The RF-1 requires 3/8" AN male fittings. This style fitting eliminates flow "dead space" and also eliminates the need for specially designed fittings or adhesive inserts. By creating a streamline fluid passage, color change time of the meter is improved.

SPECIFICATIONS

Material Viscosity Range

Flow Rate:	.01-.50 GPM (.04-1.9 LPM)
Accuracy:	+/- 0.5% (system dependent)
Working Pressure:	500 psi (345 bar) MWP @ 100°F
Temperature:	180°F (85°C)
Signal Output:	2 Channel Quadrature 30,000 PPG (8100 PPL)
Power:	8-24 VDC

Materials

Body:	303 Stainless Steel
Gears:	Stainless Steel (Hardened)
Bushings:	Carbide
Shafts:	Carbide
Seal:	Adhesive
Filtration:	100 Mesh (maximum)
Connections:	Threaded 3/8" AN (F)
Weight:	4.5 lbs. (2.0 Kg)

INSTALLATION

The unit may be mounted using the bolt pattern shown in Figure 1. [2] 1/4 - 20 bolts should be used. Always mount the flowmeter with the gear faces perpendicular to the horizon of the earth (i.e. Vertical). This minimizes the effect of gravity on the gears. The direction of flow must be plumbed as marked on the side label of the meter. The fluid inlet is opposite the sensor connection.

The meter should be plumbed such that flow enters at the bottom of the meter and exits at the top. This eliminates any possibility of air entrapment in the meter.

NOTES



WARNING

- ▶ This meter may be installed in Class I, Division I, Group D locations when used in conjunction with the proper Zenner Barrier.

MAINTENANCE

FLOWMETER SERVICING

Flowmeter problems can be caused by improperly filtered fluid. Particulates in the fluid can cause gear binding, resulting in improper signals for the actual flow rate. Maintain the fluid filters according to the instructions from the filter manufacturer. If repeated disassembly and cleaning for removal of solids and particulates occurs, inspect the entire fluid supply system and evaluate the system cleaning cycle.

Fluid back-up, that is reverse flow, can cause re-acted/catalyzed material to enter the flow-meter. Reverse flow will be detected by the 2k controls and the system will shut down. The flowmeter should be cleaned immediately, before the fluid sets-up.

Under normal operation the magnetic sensors or electrical connections will not require replacement.

SERVICE

Disconnect sensor cable [1] from the flowmeter sensor [2]. Remove meter for service to a suitable clean area to perform maintenance. Using a 3/16" Allen wrench, remove all 10 [3] bolts. Pull the sensor section STRAIGHT apart from the gear pocket section. If the body halves do not slide apart easily, DO NOT pry them apart with screwdrivers, etc. Rather, replace a few of the bolts and only thread them in a few turns, then tap the top of the bolts with a soft mallet, while holding the top half of the body. Pull the gears and pins from the gear pocket section. Clean and replace worn parts as necessary. Install new adhesive o-ring [7]. Install all parts the order they were removed. Install flated portion of shafts [5] toward gears (see Figure 1). Push the two covers together, aligning the pins and holes by hand.

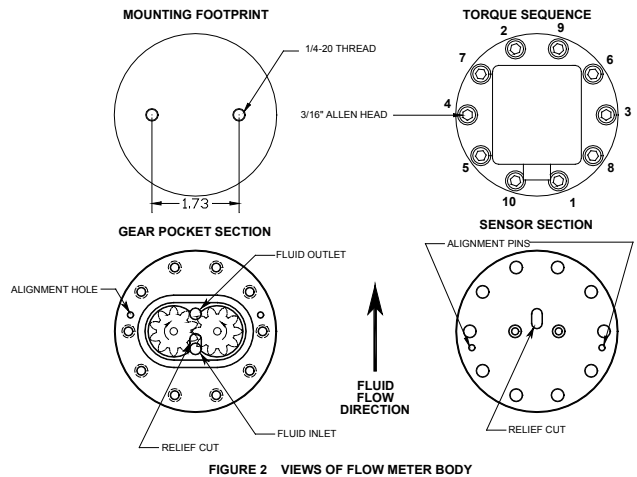

Figure 1: Views of Flow Meter Body

NOTE

There is only one way to install the sensor section and the gear pocket section.

Snug all screws down. Tighten the screws in the sequence pattern shown in Figure 1 to 13 lbs-ft torque. This is a cross pattern to insure proper gasket sealing.

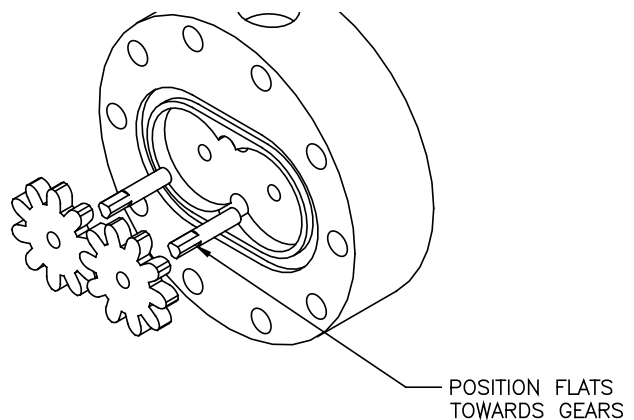

Figure 2: View of Flated Portion of Shafts

CALIBRATION

Refer to appropriate associated equipment for calibration procedure.

AUTOMATIC CLEANING OF THE FLOWMETER

Fluid Line Air Purges

Air purges are often used in automatic coating operations for rapid color changes and to minimize the amount of solvent required to flush-out the old color. Special considerations must be made when using air purges through the flowmeter.

1. Air purges do not provide the lubrication the flowmeter gears require. Lubrication is normally provided by the metered fluid or solvent.
2. Air purges can cause some coating materials to “dry” on the flowmeter shafts and gears thus affecting the performance characteristics of the flowmeter, especially when water-based materials are used.
3. Excessively long air purges will cause premature gear and shaft failure.
4. All clean cycles should begin with a solvent push to prevent drying of coating material on flowmeter parts.
5. Solvent and air “chop” cycles are recommended as the most efficient way of flushing flowmeters.
6. Air purge cycles are not recommended in water-based applications.

NOTES

PARTS IDENTIFICATION

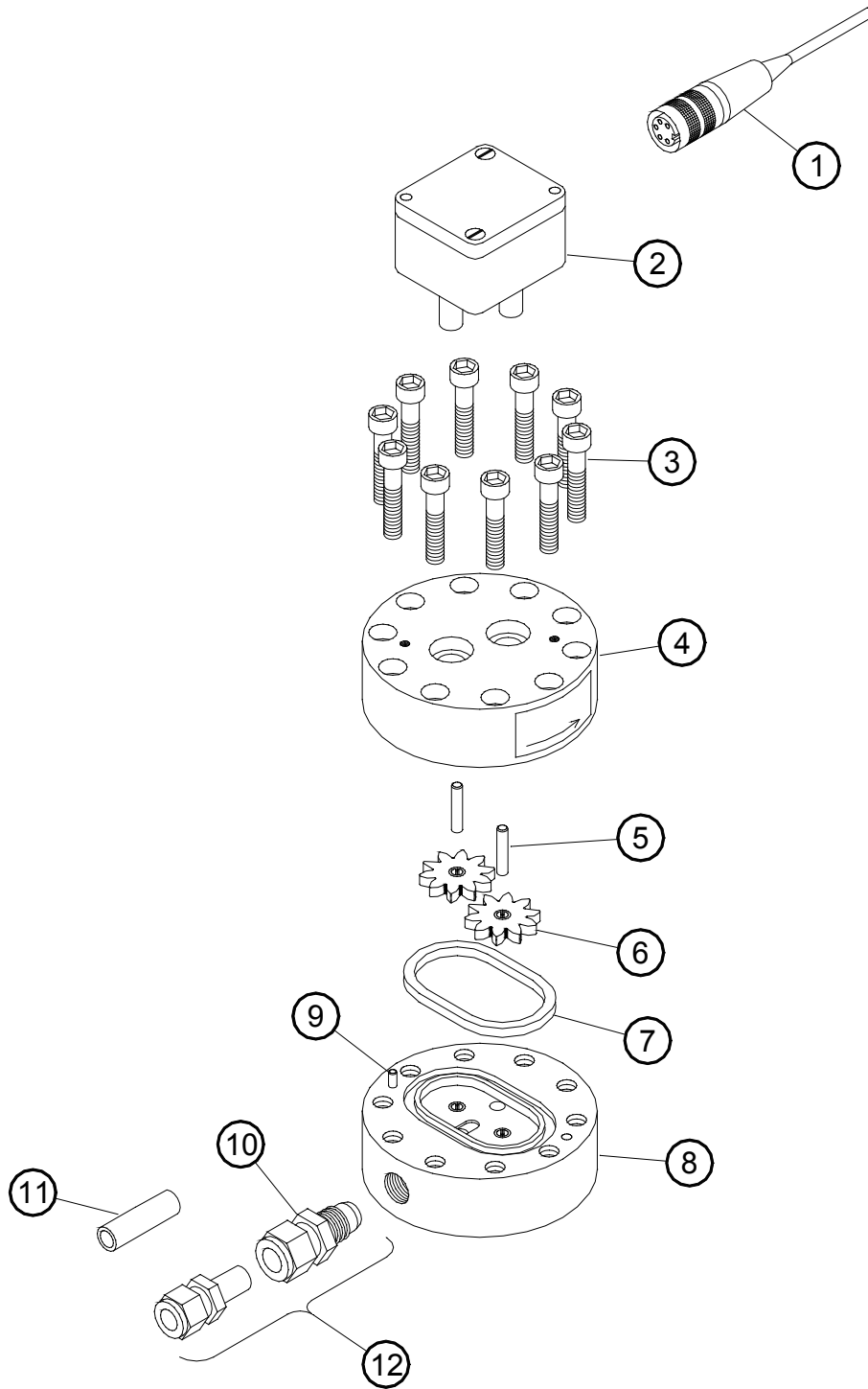

Figure 3: RF-1 Flowmeter

RF-1 FLOWMETER - PARTS LIST (Figure 3)

Item #	Part #	Description	Notes
1	TR-SSEH-585	Electrical Connector	Same connection as TR-SSEH series flowmeters
2	76252-00	Sensor Assembly	See Service Bulletin #98-11 (revised) for interchangeability with TR-SSEH-793-2 sensors
3	1/4" -20 x 1-1/4" L.	Socket Hd. Cap Screw	Must be grade 8 or better
4	N/A	Upper Housing	Cannot be purchased separately
5	76271-00	Shaft	Interchangeable with TR-SSEH-604
6	76270-00	Gear	Stamped with an 'F' or 'G' to distinguish from TR-SSEH-603 gears
7	76272-00	PTFE O-Ring	
8	N/A	Lower Housing	Cannot be purchased separately
9	N/A	Alignment Pin	Pins press fitted in and cannot be removed or replaced.
10	LSF10033-00	3/8" AN x 3/8" ODT Fit.	Optional fitting
	77104-00	3/8" AN x 3/8" NPSM (m)	Optional fitting
	77105-00	3/8" AN x 1/4" NPSM (m)	Optional fitting
11	76804-00 (-01)	3/8" OD SS Tubing	Used when replacing TR-SSEH series flowmeters on 2k Controls (or 2k880) fluid panels.
12	76850-00	Fitting Kit	Used when 1/4" OD tubing is required or preferred

WARRANTY POLICIES

LIMITED WARRANTY

Ransburg will replace or repair without charge any part and/or equipment that fails within the specified time (see below) because of faulty workmanship or material, provided that the equipment has been used and maintained in accordance with Ransburg's written safety and operating instructions, and has been used under normal operating conditions. Normal wear items are excluded.

THE USE OF OTHER THAN RANSBURG APPROVED PARTS VOIDS ALL WARRANTIES.

SPARE PARTS: One hundred and eighty (180) days from date of purchase, except for rebuilt parts (any part number ending in "R") for which the warranty period is ninety (90) days.

SPARE PARTS: One hundred and eighty (180) days from date of purchase, except for rebuilt parts (any part number ending in "R") for which the warranty period is ninety (90) days.

EQUIPMENT: When purchased as a complete unit, (i.e., guns, power supplies, control units, etc.), is one (1) year from date of purchase. **WRAPPING THE APPLICATOR IN PLASTIC, SHRINK-WRAP, ETC., WILL VOID THIS WARRANTY.**

RANSBURG'S ONLY OBLIGATION UNDER THIS WARRANTY IS TO REPLACE PARTS THAT HAVE FAILED BECAUSE OF FAULTY WORKMANSHIP OR MATERIALS. THERE ARE NO IMPLIED WARRANTIES NOR WARRANTIES OF EITHER MERCHANTABILITY OR FITNESS FOR A PARTICULAR PURPOSE. RANSBURG ASSUMES NO LIABILITY FOR INJURY, DAMAGE TO PROPERTY OR FOR CONSEQUENTIAL DAMAGES FOR LOSS OF GOODWILL OR PRODUCTION OR INCOME, WHICH RESULT FROM USE OR MISUSE OF THE EQUIPMENT BY PURCHASER OR OTHERS. EXCLUSIONS:

EXCLUSIONS:

If, in Ransburg's opinion the warranty item in question, or other items damaged by this part was improperly installed, operated or maintained, Ransburg will assume no responsibility for repair or replacement of the item or items. The purchaser, therefore will assume all responsibility for any cost of repair or replacement and service related costs if applicable.

MANUAL CHANGE SUMMARY

This manual was published to supercede Service Manual **FM-00-01.3** to make the following changes:

1. Added "Service Manual Price" to the "Front Cover".
2. Added "Safety Section".
3. Added "Warranty Section".
4. Added "Manual Change Summary" page.
5. Added "Service Manual Price" to the "Back Cover".
6. Revised "Contact Information" on the "Back Cover".

**Service Manual Price: €15.00 (Euro)
\$20.00 (U.S.)**

Manufacturing

1910 North Wayne Street
Angola, Indiana 46703-9100
Telephone: 260/665-8800
Fax: 260/665-8516

Technical/Service Assistance

Telephone: 800/ 233-3366 Fax: 419/ 470-2071
www.ransburg.com

Technical Support Representative will direct you to the appropriate telephone number for ordering Spare Parts.