

- Model No. MSHTE-XXXX-X
- Repair Kit (MSHTE) KK-5064
- Soft Seal Kit (MSHTE) KK-5065

MSHTE HVLP SPRAY GUN

IMPORTANT: Before using this equipment, read all safety precautions and instructions. Retain for future use.

DESCRIPTION

Designated the HTE (High Transfer Efficiency) Atomizing System, this new process requires lower air volume resulting in higher transfer efficiencies and reduced over-spray. There are several advantages to the atomizing process:

- A. HTE requires much lower fluid pressures than air-assist airless, and a pressure tank or diaphragm pump can be used for fluid delivery.
- B. Atomization is excellent, producing a low pressure, low velocity spray non-injurious to operators.
- C. A conventional tapered needle is employed. Since a tapered needle is used, the spray gun can be "feathered" by the operator in the same manner as a conventional spray gun.

HTE provides a unique process of atomization.

- A. An elongated "cat-eye" orifice in the fluid tip produces a flattened fluid stream that requires considerably less air to atomize than the customary cylindrical stream. This feature also aids in forming a flat spray pattern.
- B. Atomization occurs by mixing air with the flattened fluid stream. A conical fluid tip assembly causes the horn air to be directed against the fluid stream.
- C. Small air jets oriented around the air nozzle horns break up the fluid (fingers) at the edges of the pattern. In addition, this feature aids in keeping the fluid tip clean.

The MSHTE HVLP spray gun is a midsize, lightweight spray gun. Fluid passages are 300 grade stainless steel. Fluid tips and needles are 400 grade stainless.

OPERATING PRESSURES

Air - 20 PSI Maximum
Fluid - 100 PSI Maximum

Note

This gun may be used with chlorinated solvents; but, see Page 2 for additional warnings.

Note

The MSHTE HVLP spray gun is not suitable for highly abrasive materials (i.e. porcelain enamel, certain mica paints, etc).

OPERATION

1. Since the fluid tip assembly has a relatively small orifice, the material must be free of large particles. Should these particles be present it will be necessary to strain the material.
2. Set the fluid pressure to 45-80 PSI. **Warning: Do not exceed 100 PSI.** Keep fluid pressure as low as possible for adequate spray.
3. Set the atomizing pressure to 5-10 PSI. Keep air pressure as low as possible to minimize bounce-back and over-spray.
4. The spray gun is now ready for application.
5. Spray a sample product. Excessive fluid flow will result in heavy center spray patterns. In this case it will be necessary to decrease the fluid pressure or change to a smaller tip.

Insufficient flows may cause pattern to split. In this case, it may be necessary to increase the fluid pressure. **Do not exceed 100 PSI.**

PREVENTIVE MAINTENANCE

To clean air cap and fluid tip, brush exterior with a stiff bristle brush. If necessary to clean cap holes, use a broom straw or toothpick. **Never use a wire or hard instrument.** This may scratch or burr holes causing a distorted spray pattern.

To clean fluid passages, remove excess material at source, then flush with a suitable solvent using a device such as the SolventSaver™ (see Accessories). Wipe gun exterior with a solvent dampened cloth. Never completely immerse in solvent as this is detrimental to the lubricants and packings.

FLUID INLET GASKET (6) REPLACEMENT INSTRUCTIONS

1. Remove fluid inlet adapter with appropriate wrench.
2. Clean loctite from gun body inlet threads and seal area.
3. Place gasket (6) squarely onto fluid inlet adapter and push down until it is flat against the shoulder.

4. Place a couple of drops of thread sealant (i.e. Loctite med. strength #242 blue or equal) on threads before installing fluid inlet adapter.
5. Torque fluid inlet adapter to 20-25 ft. lbs. and tighten locknut.

CAUTION

To prevent damage to the fluid nozzle assembly (3) or fluid needle (26), be sure to either 1) pull the trigger and hold while tightening or loosening the fluid nozzle assembly or 2) remove fluid needle adjusting screw (30) to relieve spring pressure against needle collar.

SPRAY GUN LUBRICATION

Daily, apply a drop of gun lube at trigger bearing stud (20) and the stem of the air valve assembly (18). The shank of the fluid needle (26) where it enters the packing nut (11) should also be oiled. The fluid needle packing (10) should be lubricated periodically. **Make sure baffle (5) and retaining ring (1) threads are clean and free of foreign matter. Before assembling retaining ring to baffle, clean the threads thoroughly, then add two drops of •SSL-10 spray gun lube to threads.**

The fluid needle spring (28) and air valve spring (16) should be coated on the ends with a very light grease, ensuring that any excess grease will not clog the air passages. For best results, lubricate the points indicated daily using •SSL-10 spray gun lube.

- A. Trigger points
- B. Packing
- C. Adjusting valve
- D. Baffle & retaining ring threads
- E. Air valve cartridge

- "Material Safety Data Sheet" available from DeVilbiss upon request.

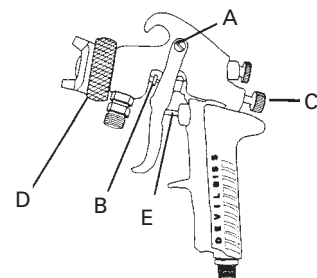

SAFETY PRECAUTIONS

This manual contains information that is important for you to know and understand. This information relates to USER SAFETY and PREVENTING EQUIPMENT PROBLEMS. To help you recognize this information, we use the following symbols. Please pay particular attention to these sections.



Important safety information - A hazard that may cause an injury or loss of life.







Important information that tells how to prevent damage to equipment.

Note

Information that you should pay special attention to.



The following hazards may occur during the normal use of this equipment. Please read the following chart before using this equipment.

HAZARD	CAUSE	SAFEGUARD
	Solvent and coatings can be highly flammable or combustible, especially when sprayed.	<p>Adequate exhaust must be provided to keep air free of accumulations of flammable vapors.</p> <p>Smoking must never be allowed in the spray area.</p> <p>Fire extinguishing equipment must be present in the spray area.</p>
	During cleaning and flushing, solvents can be forcefully expelled from fluid and air passages. Some solvents can cause eye injury.	Wear eye protection.
	Certain materials may be harmful if inhaled, or if there is contact with skin.	<p>Follow the requirements of the Material Safety Data Sheet by your coating material manufacturer.</p> <p>Adequate exhaust must be provided to keep the air free of accumulations of toxic materials.</p> <p>Use a mask or respirator whenever there is a chance of inhaling sprayed materials. The mask must be compatible with the material being sprayed and its concentration. Equipment must be as prescribed by an industrial hygienist or safety expert, and be NIOSH approved.</p>
	Halogenated hydrocarbon solvents - for example; methylene chloride and 1, 1, 1 - Trichloroethane can chemically react with aluminum. The chemical reaction caused by these solvents reacting with aluminum can become violent and lead to an equipment explosion.	This gun may be used with these solvents. However, aluminum is widely used in other spray application equipment - such as material pumps, regulators, valves & cups. Check all equipment items before use and make sure they can also be used safely with these solvents. Read the label or data sheet for the material you intend to spray. If in doubt as to whether or not a coating or cleaning material is compatible, contact your material supplier.
<p>General Safety</p>	Improper operation or maintenance of equipment.	Operators should be given adequate training in the safe use & maintenance of the equipment (in accordance with the requirements of NFPA-33, Chapter 15). Users must comply with all local & national codes of practice and insurance company requirements governing ventilation, fire precautions, operation, maintenance and house-keeping. These are OSHA Sections 1910.94 and 1910.107 and NFPA-33. Risk is reduced by avoiding or lessening factors 1-7.
<p>Cumulative Trauma Disorders "CTD's"</p> <p>CTD's, or musculoskeletal disorders, involve damage to the hands, wrists, elbows, shoulders, neck and back. Carpal tunnel syndrome and tendinitis (such as tennis elbow or rotator cuff syndrome) are examples of CTD's</p>	<p>Use of hand tools may cause cumulative trauma disorders "CTD's".</p> <p>CTD's, when using hand tools, tend to affect the upper extremities. Factors which may increase the risk of developing a CTD include:</p> <ol style="list-style-type: none"> 1. High frequency of the activity. 2. Excessive force, such as gripping, pinching or pressing with the hands and fingers. 3. Extreme or awkward finger, wrist, or arm positions. 4. Excessive duration of activity. 5. Tool vibration. 6. Repeated pressure on a body part. 7. Working in cold temperatures. <p>CTD's can also be caused by such activities as sewing, golf, tennis and bowling, to name a few.</p>	<p>Pain, tingling, or numbness in the shoulder, forearm, wrist, hands or fingers, especially during the night, may be early symptoms of a CTD. Do not ignore them. Should you experience any such symptoms, see a physician immediately. Other early symptoms may include vague discomfort in the hand, loss of manual dexterity, and nonspecific pain in the arm. Ignoring early symptoms and continued repetitive use of the arm, wrist and hand can lead to serious disability.</p>

FLUID TIP SELECTION

Factors to consider in selecting a fluid tip for an air-assisted airless spray gun include: (1) the size of the parts being sprayed; (2) the production line speed; (3) the material flow rate and film thickness; (4) the viscosity of the material applied; (5) the type of material applied; and (6) the quality of atomization of the coating required. The selection of a fluid tip necessary to perform a specific spraying job is best determined through a combination of experimentation and expert advice from your material equipment suppliers.

CHART 1

SPRAY TIP SELECTION		
PART NO.	SIZE	FAN WIDTH
113-01706	.017	4"-6"
113-01708	.017	6"-8"
113-01710	.017	8"-10"
113-01712	.017	10"-12"
113-01714	.017	12"-14"
113-01716	.017	14"-16"
113-01718	.017	16"-18"
PART NO.	SIZE	FAN WIDTH
113-01906	.019	4"-6"
113-01908	.019	6"-8"
113-01910	.019	8"-10"
113-01912	.019	10"-12"
113-01914	.019	12"-14"
113-01916	.019	14"-16"
113-01918	.019	16"-18"
PART NO.	SIZE	FAN WIDTH
113-02110	.021	8"-10"
113-02112	.021	10"-12"
113-02114	.021	12"-14"
113-02116	.021	14"-16"
113-02118	.021	16"-18"
PART NO.	SIZE	FAN WIDTH
113-02410	.024	8"-10"
113-02412	.024	10"-12"
113-02414	.024	12"-14"
113-02416	.024	14"-16"
113-02418	.024	16"-18"
PART NO.	SIZE	FAN WIDTH
113-02710	.027	8"-10"
113-02712	.027	10"-12"
113-02714	.027	12"-14"
113-02716	.027	14"-16"
113-02718	.027	16"-18"

PARTS LIST

Ref. No.	Replacement Part No.	Description	Individual Parts Req
1	54-4160	Retaining Ring	1
2	54-4980	Air Cap	1
3	45-10000	Nozzle Assembly	1
•4 ▲	GTI-33-K5	Seal Kit (Kit of 5)	1
5	GTI-425	Baffle Assembly	1
6	MSV-3-K10	Gasket (blue)	1
7	----	Locknut	1
8	----	Fluid Inlet Adapter 3/8" NPS(M)	1
9	JGA-4044	Fluid Inlet and Nut Kit	1
•10 ▲	JGV-463-K3	Needle Packing Assembly (Kit of 3)	1
11	34411-122-K10	Fluid Needle Packing Nut (Kit of 10)	1
•12	JGA-14-K25	Snap Ring (Kit of 25)	1
•13	JGA-15-K25	Washer (Kit of 25)	1
•14 ▲	JGS-26-K25	U-Cup (Kit of 25)	1
•15	JGS-431-K25	Air Valve Assembly (Kit of 25)	1
•16	MBD-12-K25	Spring (Kit of 25)	1
•17 ▲	JGS-72-K10	Gasket (Kit of 10) (PTFE)	2
18	JGS-449-1	Air Valve Assembly	1
•19	----	Screw	1
20	----	Trigger Bearing Stud	1
21	JGS-478	Stud and Screw Kit (Kit includes 3 studs and 5 screws)	1
22	JGS-477-1	Trigger, Stud & Screw Kit (Kit includes 1 each)	1
23	JGA-132	Plug	1
24	MSA-3	Connector 1/4" NPS	1
25	54-4162	Air Valve Plug	1
26	JGA-402-E	Fluid Needle	1
27	----	Gun Body Bushing	1
•28	MBD-19-K10	6# Spring (Kit of 10)	1
	MSA-4-K10	4# Spring (Kit of 10) (Optional)	1
•29	-----	Spring Pad (included with #28 and 31)	1
30	JGS-16	Fluid Needle Adjusting Screw	1
31	JGA-4041	Bushing, Spring, Knob Kit	1
32	See Chart 1	Spray Tip Assembly	1

• A quantity of necessary parts is included in Repair Kit KK-5064. This kit should be kept on hand for service convenience.

▲ A quantity of necessary parts is included in Soft Seal Kit KK-5065.

Suffixes -K3, -K5, -K10, etc. designate kits of multiple parts. (Example) GTI-33-K5 is a kit of 5 seals.

Important Regulatory Note

With an inlet air pressure of 20 p.s.i., the compliant air cap registers 10 p.s.i. of atomization air. The MSHT H.V.L.P. gun operates at high transfer efficiencies and fully complies with all government regulations for H.V.L.P. spray guns.

Maximum dynamic gun inlet pressure:
20 p.s.i.

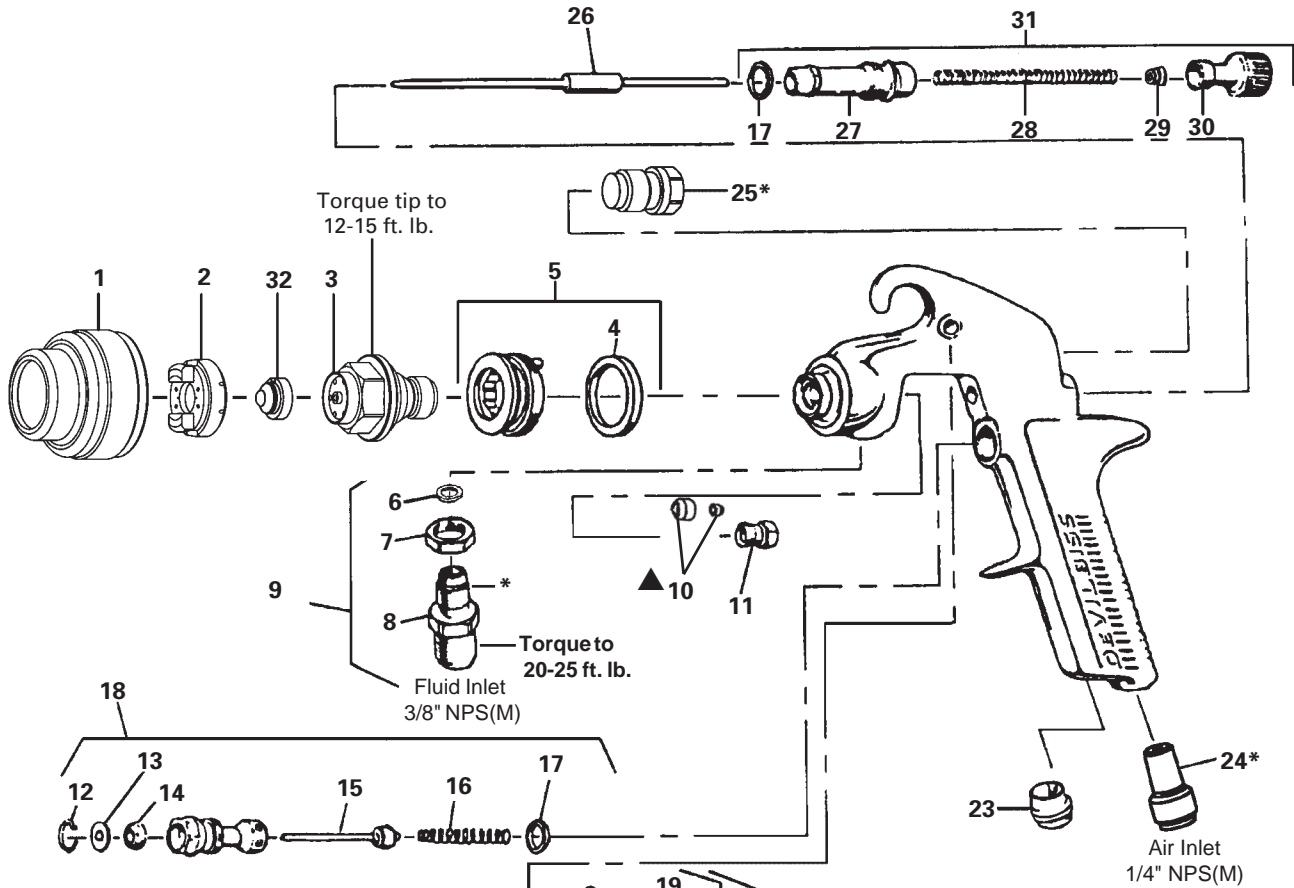

▲ Detail Ref. No. 10 - Two piece packing covered by U.S. Patent No. 5,209,501.
 + Tapered edge faces out towards packing nut.

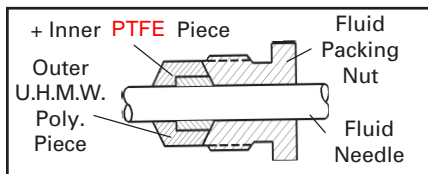

GTI-33 Baffle Seal Replacement (4)

1. Remove fluid tip (3).
2. Remove baffle (5).
3. Remove seal (4) from baffle.
4. Assemble seal to baffle with **angled side up** as shown at right.
5. Install baffle on gun.
6. Install fluid tip (3) and tighten to 12-15 ft-lbs.

NOTE



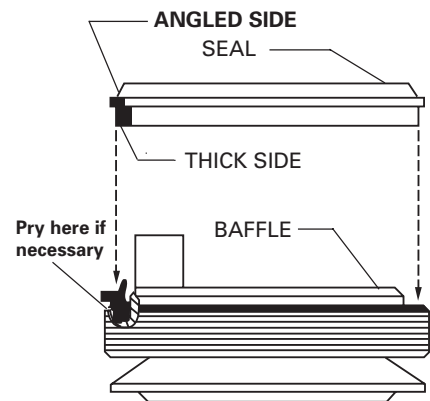

The seal should be a tight fit on the baffle. If it is a loose fit on the baffle, assure that it is assembled with the angled side up.

NOTE

The seal is designed to be a tight fit on the baffle. The seal should be able to be removed using your fingers. If you are unable to remove the seal using your fingers, insert a small screwdriver between the outer lip and the back of the baffle and pry the seal off.



TROUBLESHOOTING









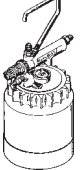

CONDITION	CAUSE	CORRECTION
Heavy top or bottom pattern 	Horn holes plugged. Obstruction on top or bottom of fluid tip. Cap and/or tip seat dirty.	Clean. Ream with non-metallic point. Clean. Clean.
Heavy right or left side pattern 	Left or right side horn holes plugged. Dirt on left or right side of fluid tip. Remedies for the top-heavy, bottom-heavy, right-heavy and left-heavy patterns: 1) Determine if the obstruction is on the air cap or the fluid tip. Do this by making a test spray pattern. Then, rotate the cap one-half turn and spray another pattern. If the defect is inverted, obstruction is on the air cap. Clean the air cap as previously instructed. 2) If the defect is not inverted, it is on the fluid tip. Check for a fine burr on the edge of the fluid tip. Remove with #600 wet or dry sand paper. 3) Check for dried paint just inside the opening. Remove paint by washing with solvent.	Clean. Ream with non-metallic point. Clean.
Heavy center pattern 	Fluid pressure too high for atomization air (pressure feed). Material flow exceeds air cap's capacity. Atomizing pressure too low. Material too thick.	Balance air and fluid pressure. Thin or lower fluid flow. Increase pressure. Thin to proper consistency.
Split spray pattern 	Atomization air pressure too high. Fluid pressure too low (pressure feed only).	Reduce at transformer or gun. Increase fluid pressure (increases gun handling speed).
Jerky or fluttering spray 	*Loose or damaged fluid tip/seat. Material level too low. Obstruction in fluid passage. Loose or broken fluid tube or fluid inlet nipple. Dry or loose fluid needle packing nut.	Tighten or replace. Refill. Backflush with solvent. Tighten or replace. Lubricate or tighten.
Will not spray	No air pressure at gun. Fluid needle adjusting screw not open enough.	Check air supply and air lines. Open fluid needle adjusting screw.
Excessive overspray	Too much atomization air pressure Gun too far from work surface. Improper stroking (arcing, gun motion too fast).	Reduce pressure. Adjust to proper distance. Move at moderate pace, parallel to work surface.
Excessive fog	Too much, or too fast-drying thinner. Too much atomization air pressure.	Remix properly. Reduce pressure.
Dry Spray	Air pressure too high. Gun tip too far from work surface. Gun motion too fast. Gun out of adjustment	Reduce air pressure. Adjust to proper distance. Slow down. Adjust.
Fluid leaking from packing nut	Packing nut loose. Packing worn or dry	Tighten, do not bind needle. Replace or lubricate.
Fluid leaking or dripping from front of pressure feed gun	Packing nut too tight. Dry packing. Fluid tip or needle worn or damaged. Foreign matter in tip. Fluid needle spring broken. Wrong size needle or tip.	Adjust. Lubricate. Replace tip & needle with lapped sets. Clean. Replace. Replace.
Runs and sags	Too much material flow. Material too thin. Gun tilted on an angle, or gun motion too slow.	Adjust gun or reduce fluid pressure. Mix properly or apply light coats. Hold gun at right angle to work and adapt to proper gun technique.

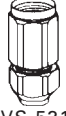
*Most common problem.

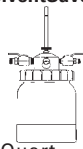
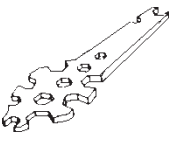
TROUBLESHOOTING (continued)

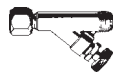
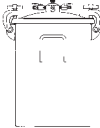
CONDITION	CAUSE	CORRECTION
Thin, sandy coarse finish drying before it flows out	Gun too far from surface. Too much air pressure. Improper thinner being used.	Check distance. Normally approx. 8". Reduce air pressure and check spray pattern. Follow paint manufacturer's mixing instructions.
Thick, dimpled finish "orange peel".	Gun too close to surface. Too much material coarsely atomized. Air pressure too low. Improper thinner being used. Material not properly mixed. Surface rough, oily, dirty.	Check distance. Normally approx. 8". Increase air pressure or decrease fluid pressure. Increase air pressure or reduce fluid pressure. Follow paint manufacturer's mixing instructions. Follow paint manufacturer's mixing instructions. Properly clean and prepare.

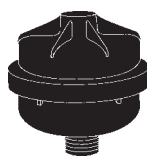
ACCESSORIES

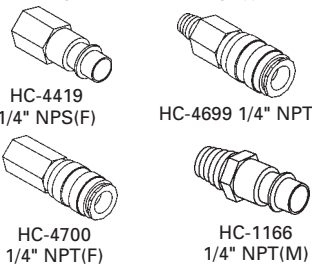
<p>KB-555 Alum. & KB-545-SS Stainless Steel 2 Qt. Pressure Feed Cups</p>  <p>Includes a 0-30 psi gauge.</p>	<p>JGA-52-K10 Leather Packings</p>  <p>Used when abrasive materials are sprayed (i.e. porcelain enamel). Use (2) JGA-52 packings in place of JGV-463 packing.</p>	<p>VS-531 Low Pressure Strainers</p>  <p>The VS-531 Low Pressure Fluid Strainer provides a final filter for trapping foreign particles in the paint supply.</p>	<p>HAV-500 or HAV-501 Adjusting Valve (HAV-501 Shown)</p>  <p>Use to control air pressure at gun. (HAV-500 has no gauge.)</p>	<p>Spray Gun Lube SSL-10 (2 oz. bottle)</p>  <p>Compatible with all paint materials: contains no silicone or petroleum distillates to contaminate paint. MSDS available upon request.</p>	<p>HD-503 SolventSaver™</p>  <p>2 Quart Hose Cleaner used to clean the inside of hose and material passages of gun. 2 Gallon galvanized also available.</p>
<p>WR-103 Wrench</p>  <p>Contains all necessary tip, hose and nut sizes used on or with gun.</p>	<p>GTI-415 Air Adjusting Valve</p>  <p>Allows air adjustment at the gun. Replaces JGA-132 plug.</p>	<p>42884-214-K5 (3/8") & 42884-215-K10 (5/8") Cleaning Brushes</p>  <p>These brushes are helpful in cleaning threads and recesses of gun body.</p>	<p>P-H-5516 Air Adjusting Valve</p>  <p>Enables user to control and reduce air usage at the gun. Ideal for low pressure spraying.</p>	<p>QMGZ SolventSaver™ Hose/Gun Cleaner</p>  <p>2 Gallon galvanized tank used to clean the inside of hose and material passages of the gun.</p>	<p>MSA-4-K10 Fluid Needle Spring (replaces MBD-19)</p>  <p>Provides reduced spring force (4 lbs. versus 6 lbs.) for easier trigger pull.</p>
<p>Millennium 3000 Twin Cartridge, Paint Spray Respirator</p>  <p>NIOSH-Certified (TC-84A-1623) for respiratory protection in atmospheres not immediately dangerous to life.</p>	<p>HAF-507 Whirlwind™ In-Line Air Filter</p>  <p>Removes water, oil, and debris from the air line.</p>	<p>29-3100 Scrubs® Hand Cleaner Towels</p>  <p>Scrubs® are a pre-moistened hand cleaner towel for painters. No water is needed.</p>	<p>Quick Disconnect Approved for HVLP Guns (Air) High Flow Ball and Ring Type</p>  <p>HC-4419 1/4" NPS(F) HC-4699 1/4" NPT(M) HC-4700 1/4" NPT(F) HC-1166 1/4" NPT(M)</p>		

WARRANTY

This product is covered by DeVilbiss' 1 Year Limited Warranty.

DeVilbiss Worldwide Sales and Service Listing: www.devilbiss.com

Industrial Finishing

DeVilbiss has authorized distributors throughout the world. For technical assistance or the distributor nearest you, see listing below.

U.S./Canada Technical Service Office:

195 Internationale Blvd., Glendale Heights, IL 60139
Toll-Free Telephone: 1-888-992-4657 (U.S.A. and Canada only)
Toll-Free Fax: 1-800-368-8401

