

GTI-500P and GTI-520P COMPLIANT PRESSURE FEED HVLP SPRAY GUNS

IMPORTANT: Before using this equipment, read all safety precautions and instructions. Keep for future use.

DESCRIPTION

These pressure feed high volume low pressure GTI guns are designed to apply a wide variety of finishing materials. These guns are manufactured to provide maximum transfer efficiency by **limiting air cap pressure to 10 psi (complies with rules issued by SCAQMD and other air quality authorities).**

These guns will produce approximately 10 psi cap pressure at 30 psi gun inlet pressure. Air cap test kits are available (see ACCESSORIES) which can be utilized to set the exact air cap pressure. Air consumption for the GTI-500P (#100 cap) is 16 SCFM at 10 psi air cap pressure. Air consumption for the GTI-520P (#2000 cap) is 15.5 SCFM at 10 psi air cap pressure.

NOTE

These guns include 400 series stainless steel fluid tips and needles. Guns may be used with chlorinated solvent materials. See page 2 for additional warnings.

Important: These guns may be used with most common coating and finishing materials. They are designed for use with mildly corrosive and non-abrasive materials. If used with other high corrosive or abrasive materials, it must be expected that frequent and thorough cleaning will be required and the necessity for replacement of parts will be increased.

INSTALLATION

For maximum transfer efficiency, **do not use more pressure than is necessary to atomize the material being applied.**

1. Connect the gun to a clean, moisture and oil free air supply using a hose size of at least **5/16" I.D.** hose. Do not use 1/4" I.D. hose (25' x 1/4" hose at 18 CFM has a pressure loss of 25 psi. 25' x 5/16" hose at 18 CFM has a pressure loss of 8 psi).

NOTE

Depending on hose length, larger I.D. hose may be required. Install an HAV-501 air gauge at the gun handle and air cap test kit over tip. When gun is triggered on, adjust regulated pressure to desired setting to provide a maximum of 10 psi at the air cap. **Do not use more pressure than is necessary to atomize the material**

being applied. Excess pressure will create additional overspray and reduce transfer efficiency.

NOTE

If quick connects are required, use only high flow quick connects approved for HVLP use such as DeVilbiss HC-4419 and HC-4719. Other types will not flow enough air for proper gun operation.

NOTE

If an air adjusting valve is used at the gun inlet, use DeVilbiss Model HAV-500 or HAV-501. Some competitive adjusting valves have significant pressure drop that can adversely affect spray performance. Models HAV-500 and HAV-501 have minimal pressure drop, which is important for HVLP spraying.

2. Attach the fluid hose to the material inlet.

NOTE

Protective coating and rust inhibitors have been used to keep the gun in good condition prior to shipment. Before using the gun, flush it with solvents so that these materials will be removed from fluid passages.

OPERATION

Mix, prepare and strain the material to be sprayed according to the paint manufacturer's instructions.

Strain material through a 60 or 90 mesh screen.

1. Fill the pressure tank with the material.
2. Open the spreader adjustment valve (10) (Fan) by turning the valve stem counterclockwise.
3. Open fluid adjusting screw (17) by turning counterclockwise.
4. Turn on air supply to gun and pressure tank and set gun inlet pressure to lowest recommended pressure for material being sprayed. Spray a test area. Air pressure and paint flow should be adjusted to provide a uniform dispersion of atomized paint throughout the pattern. Due to the unique cone shape of the AV-2120 fluid tip, a slight back pressure is created against the fluid column. This will reduce the amount of fluid output. To compensate, increase the fluid regulator pressure

slightly. With 10 psi cap pressure, back pressure is approximately 2.0 psi. Keep air pressure as low as possible to minimize bounce-back and overspray. Excessive fluid flow will result in heavy center spray patterns. Inadequate flows may cause the pattern to split. See TROUBLESHOOTING, Page 5, if any problems occur. If finer atomization is required, increase gun inlet pressure. If a reduced fluid flow rate is required, turn fluid adjusting screw (17) clockwise until desired fluid flow is obtained.

See Spray Gun Guide, SB-2-001 latest revision, for details concerning setup of spray guns.

PREVENTIVE MAINTENANCE

To clean air cap and fluid tip, brush exterior with a stiff bristle brush. If necessary to clean cap holes, use a broom straw or toothpick if possible. **If a wire or hard instrument is used, extreme care must be used to prevent scratching or burring of the holes which will cause a distorted spray pattern.**

To clean fluid passages, remove excess material from cup, then flush with a suitable solvent. Wipe gun exterior with a solvent dampened cloth. Never completely immerse in solvent as this is detrimental to the lubricants and packings.

NOTE

When replacing the fluid tip or fluid needle, replace both at the same time. Using worn parts can cause fluid leakage. See Chart 2. Also, replace the needle packing at this time. Lightly lubricate the threads of the fluid tip before reassembling. Torque to 12-15 ft. lbs. Do not overtighten the fluid tip.

CAUTION

To prevent damage to fluid tip (5) or fluid needle (11), be sure to either 1) pull the trigger and hold while tightening or loosening the fluid tip, or 2) remove fluid needle adjusting screw (17) to relieve spring pressure against needle collar.

SAFETY PRECAUTIONS

This manual contains information that is important for you to know and understand. This information relates to USER SAFETY and PREVENTING EQUIPMENT PROBLEMS. To help you recognize this information, we use the following symbols. Please pay particular attention to these sections.



Important safety information - A hazard that may cause serious injury or loss of life.







Important information that tells how to prevent damage to equipment, or how to avoid a situation that may cause minor injury.

NOTE

Information that you should pay special attention to.



The following hazards may occur during the normal use of this equipment. Please read the following chart before using this equipment.

HAZARD	CAUSE	SAFEGUARDS
Fire 	Solvent and coatings can be highly flammable or combustible especially when sprayed.	Adequate exhaust must be provided to keep air free of accumulations of flammable vapors. Smoking must never be allowed in the spray area. Fire extinguishing equipment must be present in the spray area.
Solvent Spray 	During use and while cleaning and flushing, solvents can be forcefully expelled from fluid and air passages. Some solvents can cause eye injury.	Wear eye protection.
Inhaling Toxic Substances 	Certain materials may be harmful if inhaled, or if there is contact with the skin.	Follow the requirements of the Material Safety Data Sheet supplied by your coating material manufacturer. Adequate exhaust must be provided to keep the air free of accumulations of toxic materials. Use a mask or respirator whenever there is a chance of inhaling sprayed materials. The mask must be compatible with the material being sprayed and its concentration. Equipment must be as prescribed by an industrial hygienist or safety expert, and be NIOSH approved.
Explosion Hazard - Incompatible Materials 	Halogenated hydrocarbon solvents - for example; methylene chloride and 1,1,1, - Trichloroethane are not chemically compatible with the aluminum that might be used in many system components. The chemical reaction caused by these solvents reacting with aluminum can become violent and lead to an equipment explosion.	Guns with stainless steel internal passageways may be used with these solvents. However, aluminum is widely used in other spray application equipment - such as material pumps, regulators, valves, and cups. Check all equipment items before use and make sure they can also be used safely with these solvents. Read the label or data sheet for the material you intend to spray. If in doubt as to whether or not a coating or cleaning material is compatible, contact your material supplier.
General Safety	Improper operation or maintenance of equipment.	Operators should be given adequate training in the safe use and maintenance of the equipment (in accordance with the requirements of NFPA-33, Chapter 15). Users must comply with all local and national codes of practice and insurance company requirements governing ventilation, fire precautions, operation, maintenance, and housekeeping. These are OSHA Sections 1910.94 and 1910.107 and NFPA-33.
Cumulative Trauma Disorders ("CTD's") CTD's, or musculoskeletal disorders, involve damage to the hands, wrists, elbows, shoulders, neck, and back. Carpal tunnel syndrome and tendonitis (such as tennis elbow or rotator cuff syndrome) are examples of CTD's.	Use of hand tools may cause cumulative trauma disorders ("CTD's"). CTD's, when using hand tools, tend to affect the upper extremities. Factors which may increase the risk of developing a CTD include: <ol style="list-style-type: none"> 1. High frequency of the activity. 2. Excessive force, such as gripping, pinching, or pressing with the hands and fingers. 3. Extreme or awkward finger, wrist, or arm positions. 4. Excessive duration of the activity. 5. Tool vibration. 6. Repeated pressure on a body part. 7. Working in cold temperatures. CTD's can also be caused by such activities as sewing, golf, tennis, and bowling, to name a few.	Pain, tingling, or numbness in the shoulder, forearm, wrist, hands, or fingers, especially during the night, may be early symptoms of a CTD. Do not ignore them. Should you experience any such symptoms, see a physician immediately. Other early symptoms may include vague discomfort in the hand, loss of manual dexterity, and nonspecific pain in the arm. Ignoring early symptoms and continued repetitive use of the arm, wrist, and hand can lead to serious disability. Risk is reduced by avoiding or lessening factors 1-7.

SPRAY GUN LUBRICATION

Daily, apply a drop of SSL-10* spray gun lube at trigger bearing stud (28) and the stem of air valve (20) where it enters air valve assembly. The shank of fluid needle (11) where it enters packing nut (9) should also be oiled. Fluid needle packing (8) should be lubricated periodically. Make sure baffle (6) and retaining ring (3) threads are clean and free of foreign matter. Before assembling retaining ring to baffle, clean the threads thoroughly, then add two drops of SSL-10 spray gun lube to threads. Fluid needle spring (14) and air valve spring (19) should be coated with a very light grease, making sure that any excess grease will not clog the air passages. For best results, lubricate the points indicated, daily.

* Not for air tools or high RPM equipment.

- A. Trigger Points
- B. Packing
- C. Adjusting Knobs
- D. Baffle Threads
- E. Air Valve Cartridge

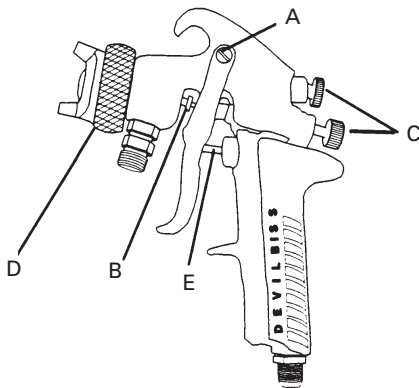

PARTS REPLACEMENT

FLUID INLET GASKET (32) REPLACEMENT INSTRUCTIONS

1. Remove fluid inlet adapter (34) with appropriate wrench.
2. Clean Loctite from gun body inlet threads and seal area.
3. Place gasket (32) squarely onto the fluid inlet adapter and push it down until it is flat against the shoulder.
4. Use medium strength thread sealant (i.e. Devcon 2242 blue, or equal) on threads before installing fluid inlet adapter.
5. Torque fluid inlet adapter to 20-25 ft. lbs. and tighten locknut.

PARTS REPLACEMENT

Figure 1 Air Cap

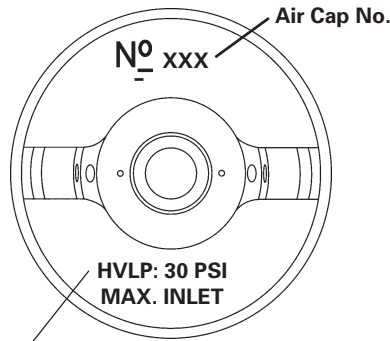

Maximum air pressure required to assure compliance of 10 PSI Max. Cap Pressure - this reading must be taken at the spray gun handle inlet fitting.

Chart 1

No on Air Cap Order →	Air Cap With Ring (Ref No. 4)
100	GTI-407-100
2000	GTI-407-2000

Chart 2

Fluid Tip and Needle

If this No. is on Needle, Order →	If This No. is on Tip, Order →	Matched Fluid Tip & Needle Assembly	Tip Size (I.D.)	
			In.	mm.
JGA-402-FF	AV-2120-FF	JGA-4045-FF	.055	1.4
JGA-402-FX	AV-2120-FX	JGA-4045-FX	.042	1.1

Note: Do not use AV-1 copper gasket with this spray gun.

GTI-33 Baffle Seal Replacement

1. Remove Fluid Tip (5).
2. Remove baffle (6).
3. Remove Seal (7) from baffle.

NOTE

The seal is designed to be a tight fit on the baffle. The seal should be able to be removed using your fingers. If you are unable to remove the seal using your fingers, insert a small screwdriver between the outer lip and the back of the baffle and pry the seal off.

4. Assemble seal to baffle with **angled side up** as shown below. **NOTE:** The seal should be a tight fit on the baffle. If it is a loose fit on the baffle, assure that it is assembled with the angled side up.
5. Install baffle on gun.
6. Install fluid tip (5) and tighten to 12-15 ft-lbs.

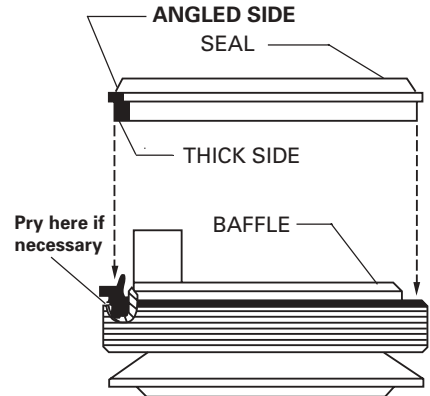

JGA-4035 Packing Replacement Instructions

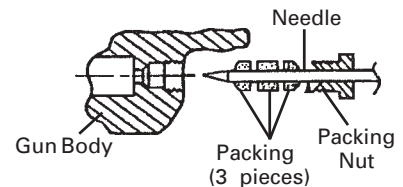

1. Remove adjusting knob and needle spring from gun.
2. Partially withdraw needle from gun body.
3. Loosen packing nut and remove.
4. Remove old packing.
5. Assemble packing nut to needle
6. Assemble packing in order shown to needle.
7. Insert needle all the way into gun body seating in tip.
8. Install needle spring and adjusting knob.
9. Thread packing nut into gun body.
10. Tighten packing nut in equal increments - no more than 1/6 turn at a time.
11. After each adjustment, pull needle open and observe needle closure.
12. If needle snaps shut, continue adjusting nut until there is evidence of needle bind or slow closing.
13. Back off packing nut 1/12 turn to the point where needle snaps shut. Packing nut must remain tight enough to prevent loosening by hand.
14. Pull needle several times to verify needle snaps shut and check packing nut for looseness.

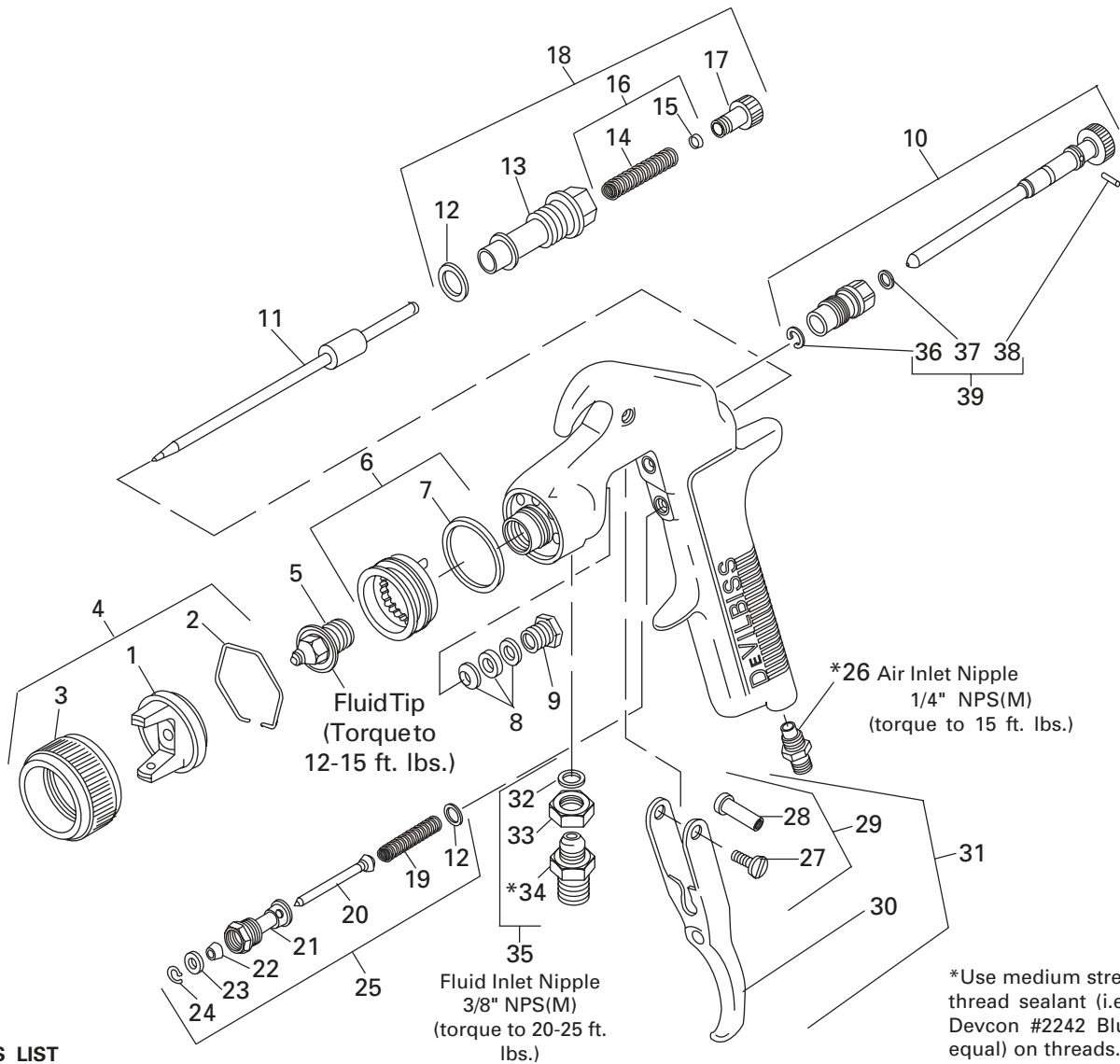





PARTS LIST

Ref. No.	Replacement Part No.	Description	Ind. Parts Req.
1	---	Air Cap	1
2	JGA-156-K10	Spring Clip (Kit of 10)	1
3	GTI-3	Air Cap Retaining Ring	1
4	See Chart 1	Air Cap & Retaining Ring	1
5	See Chart 2	Fluid Tip	1
6	GTI-425	Baffle Assembly	1
7	GTI-33-K5	Baffle Seal (Kit of 5)	1
8	JGA-4035-K5	Packing (Kit of 5)	1
9	34411-122-K10	Packing Nut	1
10	GTI-405	Spreader Valve	1
11	GTI-413	Fluid Needle	1
12	JGS-72-K10	Gasket Kit (PTFE) (Kit of 10)	2
13	---	Body Bushing	1
14	---	Fluid Needle Spring	1
15	---	Spring Pad	1
16	MBD-19-K10	Spring and Pad (Kit of 10)	1
17	GTI-414	Needle Adjusting Screw	1
18	KK-5059	Bushing, Spring, Pad and Knob Kit	1
19	---	Air Valve Spring	1
20	---	Air Valve	1

Ref. No.	Replacement Part No.	Description	Ind. Parts Req.
21	---	Air Valve Body	1
22	---	U Cup Seal	1
23	---	Washer	1
24	---	Snap Ring	1
25	JGS-449-1	Air Valve Assembly	1
26	P-MB-51	Air Inlet Nipple 1/4" NPS(M)	1
27	---	Trigger Stud Screw	1
28	---	Trigger Stud	1
29	JGS-478	Stud and Screw Kit	1
30	---	Trigger	1
31	JGS-477-1	Trigger Stud, Screw Kit	1
32	---	Fluid Inlet Gasket (PTFE)	1
33	---	Locknut	1
34	---	Fluid Inlet Adapter	1
35	JGA-4042	Fluid Inlet, Gasket, Nut Kit	1
36	---	Retaining Clip	1
37	---	Seal	1
38	---	Pin	1
39	GTI-428-K5	Clip, Seal & Pin Kit (5 each)	1

• KK-5058-2 Gun Repair Kit includes a quantity of necessary parts. Suffixes -K5, -K10 designate kits of multiple parts. Example: JGA-4035-K5 is a kit of 5 packings.

TROUBLESHOOTING

CONDITION	CAUSE	CORRECTION
Heavy top or bottom pattern 	Horn holes plugged. Obstruction on top or bottom of fluid tip. Cap and/or tip seat dirty.	Clean. Ream with non-metallic point. Clean. Clean.
Heavy right or left side pattern 	Left or right side horn holes plugged. Dirt on left or right side of fluid tip. Remedies for the top-heavy, bottom-heavy, right-heavy, and left-heavy patterns: <ol style="list-style-type: none"> Determine if the obstruction is on the air cap or the fluid tip. Do this by making a test spray pattern. Then, rotate the cap one-half turn and spray another pattern. If the defect is inverted, obstruction is on the air cap. Clean the air cap as previously instructed. If the defect is not inverted, it is on the fluid tip. Check for a fine burr on the edge of the fluid tip. Remove with #600 wet or dry sand paper. Check for dried paint just inside the opening; remove by washing with solvent. 	Clean. Ream with non-metallic point. Clean.
Heavy center pattern 	Fluid flow too high for atomization air. (Pressure Feed) Material flow exceeds air cap's capacity. Spreader adjustment valve set too low. Atomizing pressure too low. Material too thick.	Balance air pressure and fluid flow. Increase spray pattern width with spreader adjustment valve. Thin or lower fluid flow. Adjust. Increase pressure. Thin to proper consistency.
Split spray pattern 	Atomization air pressure too high. Fluid flow too low. Spreader adjusting valve set too high.	Reduce at transformer or gun. Increase fluid flow (increases gun handling speed). Adjust.
Jerky or fluttering spray 	*Loose or damaged fluid tip/seat. Baffle Seal installed incorrectly. Material level too low. Container tipped too far. Obstruction in fluid passage. Dry or loose fluid needle packing nut. Loose or broken fluid inlet nipple.	Tighten or replace. Install per directions. Refill. Hold more upright. Backflush with solvent. Lubricate or tighten. Tighten or replace.
Unable to get round spray	Spreader adjustment screw not seating properly. Air cap retaining ring loose.	Clean or replace. Tighten.
Will not spray	No air pressure at gun. Fluid needle adj. screw not open enough. Fluid too heavy. Fluid pressure too low.	Check air supply & air lines, blow out gun air passages. Open fluid needle adjusting screw. Thin material. Increase fluid pressure at tank.
Runs and sags	Too much material flow. Material too thin. Gun tilted on an angle or gun motion too slow.	Adjust gun or reduce fluid pressure. Mix properly or apply light coats. Hold gun at right angle to work and adapt to proper gun technique.
Starved spray pattern	Inadequate material flow. Low atomization air pressure.	Back fluid adjusting screw out to first thread, or increase fluid pressure at tank. Increase air pressure and rebalance gun.
Excessive overspray	Too much atomization air pressure. Gun too far from work surface. Improper stroking (arcing, gun motion too fast).	Reduce pressure. Adjust to proper distance. Move at moderate pace, parallel to work surface.
Excessive fog	Too much or too fast-drying thinner. Too much atomization air pressure.	Remix properly. Reduce pressure.
Dry spray	Air pressure too high. Gun tip too far from work surface. Gun motion too fast. Gun out of adjustment.	Reduce air pressure. Adjust to proper distance. Slow down. Adjust.
Fluid leaking from packing nut	Packing nut loose. Packing worn or dry.	Tighten, do not bind needle. Replace or lubricate.
Fluid leaking or dripping from front of gun	Packing nut too tight. Dry packing. Fluid tip or needle worn or damaged. Foreign matter in tip. Fluid needle spring broken. Wrong size needle or tip.	Adjust. Lubricate. Replace tip and needle with lapped sets. Clean. Replace. Replace.

*Most common problem.

TROUBLESHOOTING (continued)

CONDITION	CAUSE	CORRECTION
Thin, sandy coarse finish drying before it flows out	Gun too far from surface. Too much air pressure. Improper thinner being used.	Check distance. Normally approx. 6-8". Reduce air pressure and check spray pattern. Follow paint manufacturer's mixing instrs.
Thick, dimpled finish "orange peel"	Gun too close to surface. Air pressure too low. Improper thinner being used. Material not properly mixed. Surface rough, oily, dirty.	Check distance. Normally approx. 6-8". Too much material coarsely atomized. Increase air pressure or reduce fluid flow. Follow paint manufacturer's mixing instrs. Follow paint manufacturer's mixing instrs. Properly clean and prepare.

ACCESSORIES

GTI-5033-100 & GTI-5033-2000 Air Cap Test Kits



The purpose of this test kit is to measure air cap atomizing air pressure at the center air port of the air cap. Used to confirm code compliance and as a daily quality control measure.

KK-5060 Air Cap Cleaning Kit



Consists of: 2 brushes, 1 wire pick. Helps keep air cap clean and performing properly.

JGA-156-K10 Spring Clips



Joins any single piece DeVilbiss air cap with latest version MBC-368, MSA-1 or GTI-3 retaining rings. Helps prevent parts loss and provides easier assembly.

MSP-524 Twin Cartridge, Paint Spray Respirator



NIOSH-Certified (TC-84A-1623) for respiratory protection in atmospheres not immediately dangerous to life.

HARG-510 Air Regulator

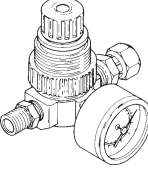

Use to maintain nearly constant outlet pressure despite changes in inlet pressure and downstream flow.

Automotive Quick Connects For HVLP Guns (Air) High Flow Type.

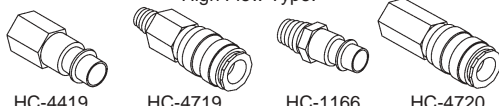

HC-4419 Stem 1/4" NPT(F)	HC-4719 Coupler 1/4" NPT(M) / NPS(M)	HC-1166 Stem 1/4" NPT(M)	HC-4720 Coupler 1/4" NPT(F)
-----------------------------	-----------------------------------------	-----------------------------	--------------------------------

Spray Gun Lube SSL-10 (2 oz. bottle)



Compatible with all paint materials; contains no silicone or petroleum distillates to contaminate paint. MSDS Sheet available upon request.

192218 Scrubs® Hand Cleaner Towels



Scrubs® are a premoistened hand cleaner towel for painters, body men and mechanics that go where you go and no water is needed.

Industrial Quick Disconnect Approved For HVLP Guns (Air) High Flow Ball and Ring Type.

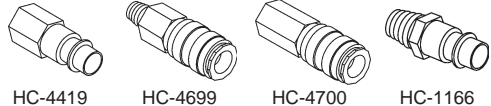

HC-4419 1/4" NPS(F)	HC-4699 1/4" NPT(M)	HC-4700 1/4" NPT(M)	HC-1166 1/4" NPT(M)
---------------------	---------------------	---------------------	---------------------

WR-103 Wrench

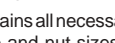

Contains all necessary tip, hose and nut sizes used on or with gun.

HAF-507 Whirlwind™ In-Line Air Filter

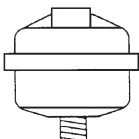

Removes water, oil, and debris from the air line.

HAV-500 OR HAV-501 Adjusting Valve
(HAV-501 SHOWN)



HAV-500 does not have pressure gauge. Use to control air usage at gun.

192212 Professional Spray Gun Cleaning Kit



Contains six precision tools designed to effectively clean all DeVilbiss, Binks, Finishline and other brand spray guns.

WARRANTY

This product is covered by DeVilbiss' 1 Year Limited Warranty. See SB-1-000 which is available upon request.

DeVILBISS WORLDWIDE SALES AND SERVICE LISTING - www.devilbiss.com

INDUSTRIAL FINISHING - DeVilbiss has authorized distributors throughout the world. **FOR TECHNICAL ASSISTANCE OR THE DISTRIBUTOR NEAREST YOU, CALL TOLL FREE 1-888-992-4657 (U.S.A. AND CANADA ONLY). FOR LOCAL CALLS, SEE LISTING BELOW.**

U.S./Canada Sales & Customer Service Office
GLENDALE HEIGHTS, IL 60139

Address
195 Internationale Blvd.

Telephone No.
(630) 237-5000
Toll Free Fax No. 1-877-790-6965

AUTOMOTIVE REFINISHING - DeVilbiss has authorized distributors throughout the world. For equipment, parts and service, check the Yellow Pages under "Automobile Body Shop Equipment and Supplies". **FOR TECHNICAL ASSISTANCE, CALL TOLL FREE 1-800-445-3988 (U.S.A. ONLY). FOR LOCAL CALLS, SEE LISTING BELOW.**

U.S. Customer Service Office
MAUMEE, OH 4353

Address
1724 Indian Wood Circle

Telephone No.
(419) 891-8100
Toll Free Fax No. 1-800-445-6643

