

GFG-517 GRAVITY FEED HIGH VOLUME LOW PRESSURE SPRAY GUN

IMPORTANT: Before using this equipment, read all safety precautions and instructions. Keep for future use.

DESCRIPTION

The gravity feed high volume low pressure GFG gun is designed to apply a wide variety of finishing materials. This gun was manufactured to provide maximum transfer efficiency by **limiting air cap pressure to 10 psi (complies with rules issued by SCAQMD and other air quality authorities).**

This gun will produce approximately 10 psi cap pressure at 80 psi gun inlet pressure, as measured at the gun inlet. An air cap test kit (see *Accessories*) should be used to insure 10 psi air cap pressure is not exceeded.

Note

This gun includes stainless steel fluid passages, 300 series SS needle and and 400 series SS fluid tip. Guns may be used with chlorinated solvent materials only if the attached gravity cup is Acetal. **Do not use aluminum cups with chlorinated solvent materials.**

Note

The GFC gravity feed cups are only included with the gun as part of the gun-cup assembly. See *Accessories* on page 6 for more information.

Important: This gun may be used with most common coating and finishing materials. It is designed for use with mildly corrosive and non-abrasive materials. If used with other high corrosive or abrasive materials, it must be expected that frequent and thorough cleaning will be required and the necessity for replacement of parts will be increased.

INSTALLATION

For maximum transfer efficiency, **do not use more pressure than is necessary to atomize the material being applied.**

1. Connect the gun to a clean, moisture and oil free air supply using a hose size of at least **5/16" I.D.** hose. Do not use 1/4" I.D. hose (25' x 1/4" hose at 18 CFM has a pressure loss of 25 psi. 25' x 5/16" hose at 18 CFM has a pressure loss of 8 psi).

Note

Depending on hose length, larger I.D. hose may be required. Install an HAV-501 air gauge at the gun handle and air cap test kit over tip. When

gun is triggered on, adjust regulated pressure to desired setting to provide a maximum of 10 psi at the air cap. **Do not use more pressure than is necessary to atomize the material being applied.** Excess pressure will create additional overspray and reduce transfer efficiency.

Note

If quick connects are required, use only high flow quick connects (see *Accessories*, page 6). Other types will not flow enough air for proper gun operation.

Note

If an air adjusting valve is used at the gun inlet, use DeVilbiss Model HAV-500 or HAV-501. Some competitive adjusting valves have significant pressure drop that can adversely affect spray performance. Models HAV-500 and HAV-501 have minimal pressure drop, which is important for HVLP spraying.

2. Attach the gravity feed cup to the material inlet.

Note

Protective coating and rust inhibitors have been used to keep the gun in good condition prior to shipment. Before using the gun, flush it with solvents so that these materials will be removed from fluid passages.

OPERATION

Mix, prepare and strain the material to be sprayed according to the paint manufacturer's instructions.

Strain material through a 60 or 90 mesh screen.

1. Fill the gravity feed cup with the material. Do not overfill. Make sure that the cup lid vent hole is clear.
2. Open the spreader adjustment valve (20) (Fan) by turning the valve stem counterclockwise.
3. Close the fluid needle adjusting screw (26) by turning clockwise.
4. Turn on air supply and set gun inlet pressure to lowest recommended pressure for material being sprayed. Best atomization will occur with 10 psig air cap pressure. However, some materials can be sprayed at lower pressures, improving transfer efficiency.

5. Spray a test area by turning fluid needle adjusting screw (26) counterclockwise until a full coat is obtained.

If the finish is too sandy and dry, the material flow may be too low for the atomization air pressure being used.

If the finish sags, there is too much material flowing for the atomization air pressure being used.

Both of the above can be corrected by increasing or decreasing the atomization air pressure or the material flow. Pattern width can be altered by turning spreader adjustment valve (20), either clockwise to decrease the width or counterclockwise to increase the width.

See Spray Gun Guide, SB-2-001 latest revision, for details concerning setup of spray guns.

PREVENTIVE MAINTENANCE

To clean air cap and fluid tip, brush exterior with a stiff bristle brush. If necessary to clean cap holes, use a broom straw or toothpick. **Never use a wire or hard instrument.** This may scratch or burr holes causing a distorted spray pattern.

To clean fluid passages, remove excess material from cup, then flush with a suitable solvent. Wipe gun exterior with a solvent dampened cloth. Never completely immerse in solvent as this is detrimental to the lubricants and packings.

Note

When replacing the fluid tip or fluid needle, replace both at the same time. Using worn parts can cause fluid leakage. Tip and needle sets are available. See Chart 2. Also, replace the needle packing at this time. Lightly lubricate the threads of the fluid tip before reassembling. Torque to 20-25 ft. lbs. Do not overtighten the fluid tip.

CAUTION

To prevent damage to fluid tip (3) or fluid needle (3), be sure to either 1) pull the trigger and hold while tightening or loosening the fluid tip, or 2) remove fluid needle adjusting screw (26) to relieve spring pressure against needle collar.

SAFETY PRECAUTIONS

This manual contains information that is important for you to know and understand. This information relates to USER SAFETY and PREVENTING EQUIPMENT PROBLEMS. To help you recognize this information, we use the following symbols. Please pay particular attention to these sections.



Important information that tells how to prevent damage to equipment, or how to avoid a situation that may cause minor injury.







Important safety information - A hazard that may cause serious injury or loss of life.

NOTE

Information that you should pay special attention to.



The following hazards may occur during the normal use of this equipment. Please read the following chart before using this equipment.

HAZARD	CAUSE	SAFEGUARDS
Fire 	Solvent and coatings can be highly flammable or combustible especially when sprayed.	Adequate exhaust must be provided to keep air free of accumulations of flammable vapors. Smoking must never be allowed in the spray area. Fire extinguishing equipment must be present in the spray area.
Solvent Spray 	During use and while cleaning and flushing, solvents can be forcefully expelled from fluid and air passages. Some solvents can cause eye injury.	Wear eye protection.
Inhaling Toxic Substances 	Certain materials may be harmful if inhaled, or if there is contact with the skin.	Follow the requirements of the Material Safety Data Sheet supplied by your coating material manufacturer. Adequate exhaust must be provided to keep the air free of accumulations of toxic materials. Use a mask or respirator whenever there is a chance of inhaling sprayed materials. The mask must be compatible with the material being sprayed and its concentration. Equipment must be as prescribed by an industrial hygienist or safety expert, and be NIOSH approved.
Explosion Hazard - Incompatible Materials 	Halogenated hydrocarbon solvents- for example; methylene chloride and 1,1,1, - Trichloroethane are not chemically compatible with the aluminum that might be used in many system components. The chemical reaction caused by these solvents reacting with aluminum can become violent and lead to an equipment explosion.	Guns with stainless steel internal passageways may be used with these solvents. However, aluminum is widely used in other spray application equipment - such as material pumps, regulators, valves, and cups. Check all equipment items before use and make sure they can also be used safely with these solvents. Read the label or data sheet for the material you intend to spray. If in doubt as to whether or not a coating or cleaning material is compatible, contact your material supplier.
General Safety	Improper operation or maintenance of equipment.	Operators should be given adequate training in the safe use and maintenance of the equipment (in accordance with the requirements of NFPA-33, Chapter 15). Users must comply with all local and national codes of practice and insurance company requirements governing ventilation, fire precautions, operation, maintenance, and housekeeping. These are OSHA Sections 1910.94 and 1910.107 and NFPA-33. Risk is reduced by avoiding or lessening factors 1-7.
Cumulative Trauma Disorders ("CTD's") CTD's, or musculoskeletal disorders, involve damage to the hands, wrists, elbows, shoulders, neck, and back. Carpal tunnel syndrome and tendonitis (such as tennis elbow or rotator cuff syndrome) are examples of CTD's.	Use of hand tools may cause cumulative trauma disorders ("CTD's"). CTD's, when using hand tools, tend to affect the upper extremities. Factors which may increase the risk of developing a CTD include: 1. High frequency of the activity. 2. Excessive force, such as gripping, pinching, or pressing with the hands and fingers. 3. Extreme or awkward finger, wrist, or arm positions. 4. Excessive duration of the activity. 5. Tool vibration. 6. Repeated pressure on a body part. 7. Working in cold temperatures. CTD's can also be caused by such activities as sewing, golf, tennis, and bowling, to name a few.	Pain, tingling, or numbness in the shoulder, forearm, wrist, hands, or fingers, especially during the night, may be early symptoms of a CTD. Do not ignore them. Should you experience any such symptoms, see a physician immediately. Other early symptoms may include vague discomfort in the hand, loss of manual dexterity, and nonspecific pain in the arm. Ignoring early symptoms and continued repetitive use of the arm, wrist, and hand can lead to serious disability.

SPRAY GUN LUBRICATION

Daily, apply a drop of SSL-10* spray gun lube at trigger bearing stud (16) and the stem of air valve (11) where it enters air valve assembly (14). The shank of fluid needle (3) where it enters packing nut (7) should also be oiled. Fluid needle packing (6) should be lubricated periodically. Make sure baffle (5) and retaining ring (1) threads are clean and free of foreign matter. Before assembling retaining ring to baffle, clean the threads thoroughly, then add two drops of SSL-10 spray gun lube to threads. Fluid needle spring (23) and air valve spring (12) should be coated with a very light grease, making sure that any excess grease will not clog the air passages. For best results, lubricate the points indicated, daily.

* Not for air tools or high RPM equipment.

- A. Trigger Points
- B. Packing
- C. Adjusting Knobs
- D. Baffle Threads
- E. Air Valve Cartridge

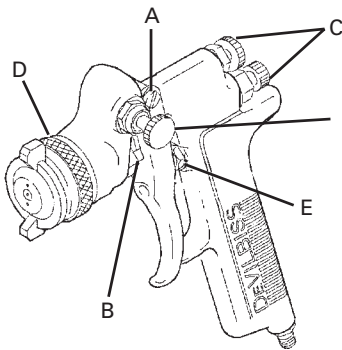

PARTS REPLACEMENT

Figure 1 Baffle

Maximum air pressure required to assure compliance of 10 PSI Max. Cap Pressure - this reading must be taken at the spray gun handle inlet fitting.

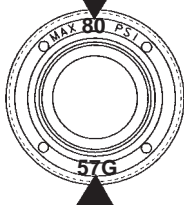

Air cap number located on face of cap - cap number must correspond with baffle number to assure 10 PSI cap pressure.

Replacement Instructions for O-ring on Spreader Adjustment Valve

1. Remove retaining ring (21) on spreader adjustment.
2. Remove valve stem and PTFE O-ring (22) from valve body.
3. Insert new PTFE O-ring (22) in valve body. Make sure it is pushed past the threads.
4. Insert valve stem.
5. Reinstall retaining ring (21).

Chart 1

AIR CAP & BAFFLE COMBINATION			
No. Stamped on Parts		Set	
Air Cap	Baffle	Ref. No. 2	Ref. No. 5
Part No.	Baffle	Air Cap	Baffle
57	57G	JGHV-101-57	GFHV-457-57

Chart 2

Fluid Tips and Needles for use with JGHV-101-57 Cap

If This No. On Tip, Order →	Matched Tip & Needles Ref. No. 3	Tip Size I.D.	
		In.	mm
AV-2125-DFE	JGA-4046-14	0.055	1.4
AV-2125-DFW	JGA-4046-16	0.063	1.6
AV-2125-DE	JGA-4046-18	0.070	1.8

Graph 1 Air Flow Rates Versus Inlet Pressure (for #57 air cap)

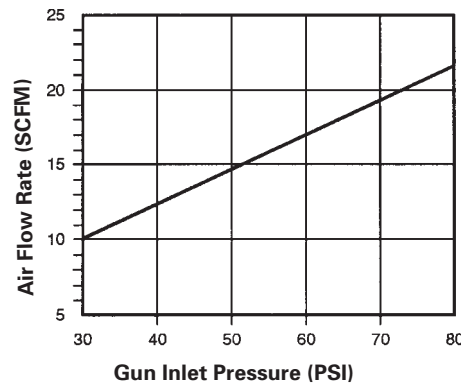

Graph 2 Cap Pressure Versus Inlet Pressure (for #57 air cap)

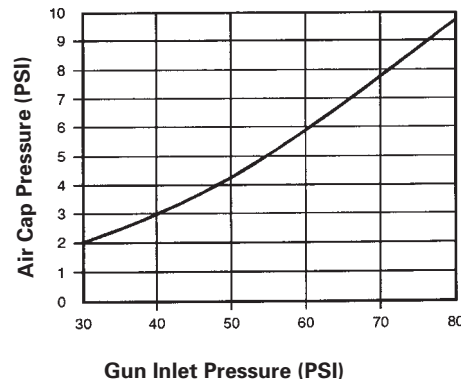

DISASSEMBLY INSTRUCTIONS - BAFFLE ASSEMBLY

The baffle design incorporates a tight, press fit with the fluid tip, assuring a positive air seal. With this design, the baffle may pull away from the gun body when the tip is removed and stay locked onto the fluid tip. If this occurs, follow the instructions below.

Note

A bench vise should be used for convenience and to avoid damage to the spray gun.

1. Secure the spray gun in a bench vise with padded jaws, or use a rag to avoid scratching the gun body.
2. Using a 1/2" socket, loosen the fluid tip three (3) turns only, which will leave about a 1/16" gap between the baffle gasket and gun body. See Figure 2. Do not loosen the fluid tip more than three (3) turns, as damage may occur.

Figure 2

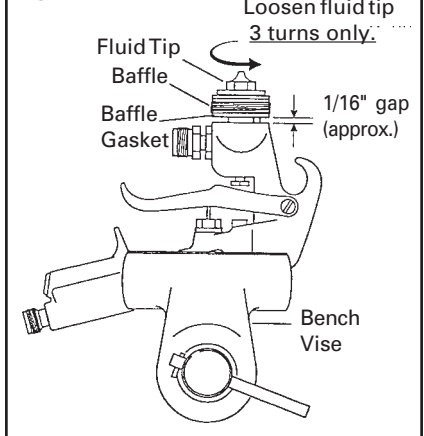

3. Place a 1" socket (12 pt.) over the fluid tip so that it rests on the top surface of the baffle. See Figure 3.
4. Press downward on the socket with sufficient force to free the baffle from the tip. See Figure 3.
5. The fluid tip and baffle can now be removed normally from the gun.

Figure 3

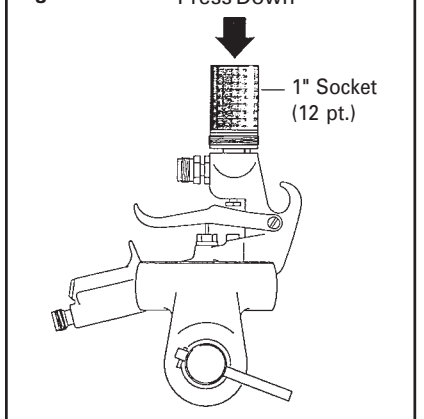

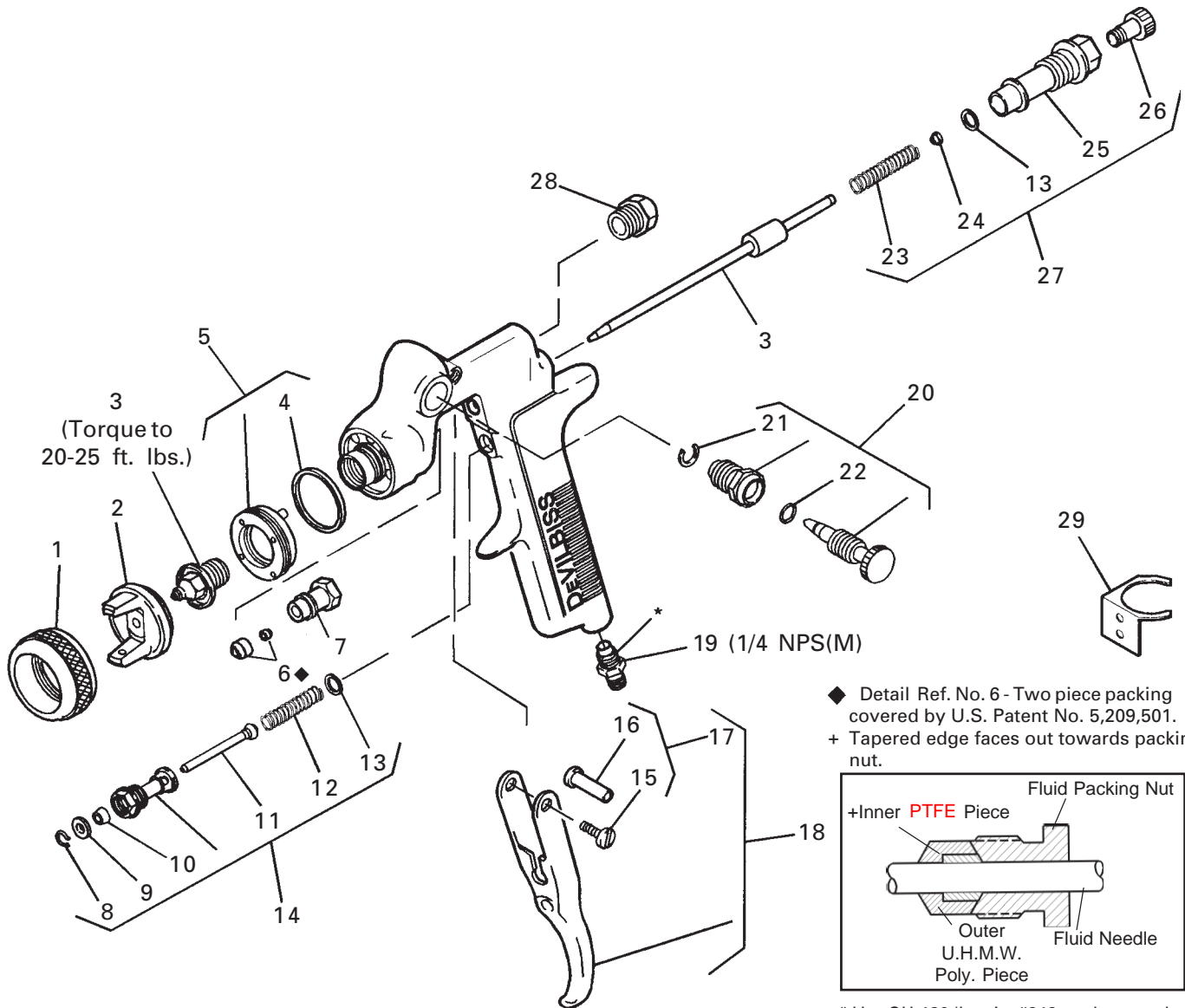

◆ Detail Ref. No. 6 - Two piece packing covered by U.S. Patent No. 5,209,501.
 + Tapered edge faces out towards packing nut.

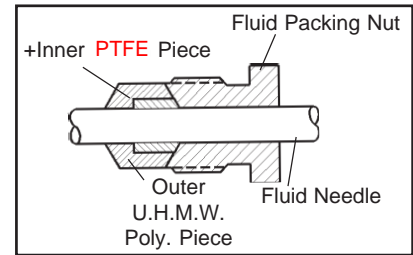

* Use QH-130 (Loctite #242 med. strength blue) sealing compound on threads.

PARTS LIST

Ref. No.	Part No.	Description	Individual Parts Req.
1	MBC-368	Retaining Ring	1
2	JGHV-101-57	Air Cap	1
3	See Chart 2	Matched Fluid Tip and Needle	1
• 4	JGD-14-K10	Seal (Kit of 10) (Polyethylene)	1
5	GFHV-457-57	Baffle	1
+ 6	JGV-463-K3	Fluid Needle Packing (Kit of 3)	1
7	34411-122-K10	Fluid Needle Packing Gland (Kit of 10)	1
• 8	—	Snap Ring	1
• 9	—	Washer	1
+ 10	—	U-Cup	1
• 11	—	Air Valve	1
• 12	—	Spring	1
+ 13	JGS-72-K10	Gasket (Kit of 10) PTFE	2
14	JGS-449-1	Air Valve Assembly	1
• 15	—	Screw	1
16	—	Trigger Bearing Stud	1
17	JGS-478	Stud and Screw Kit (Kit includes 3 studs and 5 screws)	1
18	JGS-477-1	Trigger, Stud and Screw Kit (Kit includes 1 each)	1





Ref. No.	Part No.	Description	Individual Parts Req.
19	P-MB-51	Air Inlet Connector 1/4" NPS(M)	1
20	GFG-413-2	Spreader Adjustment Valve	1
• 21	—	Retaining Ring	1
+ 22	—	O-ring PTFE	1
• 23	MBD-19-K10	Fluid Needle Spring (Kit of 10)	1
• 24	—	Spring Pad (Included with #23)	1
25	—	Gun Body Bushing	1
26	GTI-14	Fluid Needle Adjusting Screw	1
27	JGA-4041	Bushing, Spring & Knob Kit	1
28	6000-12	Plug	1
29	GFG-6	Gun Hook	1

*KK-5025 Gun Repair Kit includes a quantity of necessary parts and should be kept on hand for service convenience.
 +KK-5036 Soft Gun Repair Kit includes a quantity of necessary parts.
 Suffixes - K5, K10 designate kits of multiple parts. (Example) JGD-14-K10 is a kit of 10 seals.

WARRANTY

This product is covered by DeWalt's 1 Year Limited Warranty. See SB-1-000 which is available upon request.







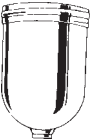

TROUBLESHOOTING

CONDITION	CAUSE	CORRECTION
Heavy top or bottom pattern 	Horn holes plugged. Obstruction on top or bottom of fluid tip. Cap and/or tip seat dirty.	Clean. Ream with non-metallic point. Clean. Clean.
Heavy right or left side pattern 	Left or right side horn holes plugged. Dirt on left or right side of fluid tip. Remedies for the top-heavy, bottom-heavy, right-heavy, and left-heavy patterns: <ol style="list-style-type: none"> Determine if the obstruction is on the air cap or the fluid tip. Do this by making a test spray pattern. Then, rotate the cap one-half turn and spray another pattern. If the defect is inverted, obstruction is on the air cap. Clean the air cap as previously instructed. If the defect is not inverted, it is on the fluid tip. Check for a fine burr on the edge of the fluid tip. Remove with #600 wet or dry sand paper. Check for dried paint just inside the opening; remove by washing with solvent. 	Clean. Ream with non-metallic point. Clean.
Heavy center pattern 	Fluid flow too high for atomization air. Material flow exceeds air cap's capacity. Spreader adjustment valve set too low. Atomizing pressure too low. Material too thick.	Balance air pressure and fluid flow. Increase spray pattern width with spreader adjustment valve. Thin or lower fluid flow. Adjust. Increase pressure. Thin to proper consistency.
Split spray pattern 	Atomization air pressure too high. Fluid flow too low. Spreader adjusting valve set too high.	Reduce at transformer or gun. Increase fluid flow (increases gun handling speed). Adjust.
Jerky or fluttering spray 	*Loose or damaged fluid tip/seat. Material level too low. Container tipped too far. Obstruction in fluid passage. Dry or loose fluid needle packing nut.	Tighten or replace. Refill. Hold more upright. Backflush with solvent. Lubricate or tighten.
Unable to get round spray	Spreader adjustment screw not seating properly. Air cap retaining ring loose.	Clean or replace. Tighten.
Will not spray	No air pressure at gun. Fluid needle adjusting screw not open enough. Fluid too heavy for gravity feed.	Check air supply and air lines, blow out gun air passages. Open fluid needle adjusting screw. Thin material and/or change to larger tip size.
Paint bubbles in cup	Fluid tip not tight.	Tighten tip to 20-25 ft-lbs.
Fluid leaking or dripping from cup lid	Cup lid loose. Dirty threads on cup or lid. Cracked cup or lid.	Tight lid. Clean. Replace cup and lid.
Starved spray pattern	Inadequate material flow. Low atomization air pressure.	Back fluid adjusting screw out to first thread, or change to larger tip size. Increase air pressure and rebalance gun.
Excessive overspray	Too much atomization air pressure. Gun too far from work surface. Improper stroking (arcing, gun motion too fast).	Reduce pressure. Adjust to proper distance. Move at moderate pace, parallel to work surface.
Excessive fog	Too much or too fast-drying thinner. Too much atomization air pressure.	Remix properly. Reduce pressure.
Dry spray	Air pressure too high. Gun tip too far from work surface. Gun motion too fast. Gun out of adjustment.	Reduce air pressure. Adjust to proper distance. Slow down. Adjust.
Fluid leaking from packing nut	Packing nut loose. Packing worn or dry.	Tighten, do not bind needle. Replace or lubricate.
Fluid leaking or dripping from front of gun	Packing nut too tight. Dry packing. Fluid tip or needle worn or damaged. Foreign matter in tip. Fluid needle spring broken. Wrong size needle or tip.	Adjust. Lubricate. Replace tip and needle with lapped sets. Clean. Replace. Replace.

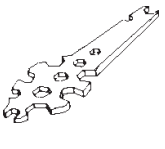
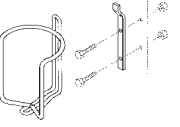
*Most common problem.

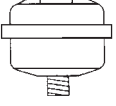
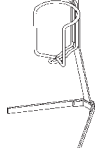
CONDITION	CAUSE	CORRECTION
Fluid dripping or leaking from bottom of cup	Cup loose on gun. Washer worn or missing below cup. Cup threads dirty.	Tighten. Replace washer. Clean.
Runs and sags	Too much material flow. Material too thin. Gun tilted on an angle, or gun motion too slow.	Adjust gun or reduce fluid flow. Mix properly or apply light coats. Hold gun at right angle to work and adapt to proper gun technique.
Thin, sandy coarse finish drying before it flows out	Gun too far from surface. Too much air pressure. Improper thinner being used.	Check distance. Normally approx. 8". Reduce air pressure and check spray pattern. Follow paint manufacturer's mixing instrs.
Thick, dimpled finish "orange peel"	Gun too close to surface. Air pressure too low. Improper thinner being used. Material not properly mixed. Surface rough, oily, dirty.	Check distance. Normally approx. 8". Too much material coarsely atomized. Increase air pressure or reduce fluid flow. Follow paint manufacturer's mixing instrs. Follow paint manufacturer's mixing instrs. Properly clean and prepare.

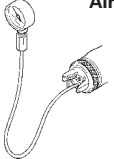
ACCESSORIES

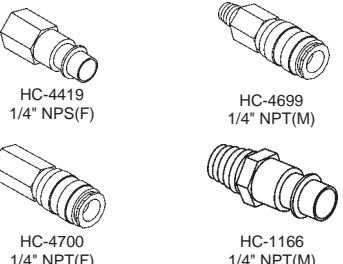
<p>GFC-501 (Acetal) 20 Oz. Cup GFC-502 (Aluminum) 32 Oz. Cup Gravity Feed Cups</p>  <p>These gravity feed cups are designed to be used with the GFG gravity feed spray gun.</p>	<p>42884-214-K5 3/8" 42884-215-K10 5/8" Cleaning Brushes</p>  <p>These brushes are helpful in cleaning threads and recesses of gun body.</p>	<p>HAV-500 OR HAV-501 Adjusting Valve (HAV-501 SHOWN)</p>  <p>HAV-500 does not have pressure gauge. Use to control air usage at gun.</p>	<p>WR-103 Wrench</p>  <p>Contains all necessary tip, hose and nut sizes used on or with gun.</p>	<p>GH-407 Gun Holder</p>  <p>(1) Wall mount bracket included with GH-407.</p>
<p>Spray Gun and Cup Combinations GFG-517 Spray Gun is sold in the following combinations: Each Kits includes (1) GFG-517 Spray Gun and (1) GFG-502 Cup: GFG-618-57DFF GFG-618-57DFW GFG-618-57DE</p>	<p>Millennium 3000 Premium Paint Spray Respirator</p>  <p>Protection against organic vapors, fumes, dusts, and mists.</p>	<p>HAF-507 Whirlwind™ In-Line Air Filter</p>  <p>Removes water, oil, and debris from the air line.</p>	<p>GH-505 Gun Holder</p>  <p>Gun holders are made to hold standard paint cups, gravity feed guns and cups, and paint filters.</p>	<p>Spray Gun Lube SSL-10 (2 oz. bottle)</p>  <p>Compatible with all paint materials; contains no silicone or petroleum distillates to contaminate paint. MSDS Sheet available upon request.</p>
<p>JGA-156-K10 Spring Clips</p>  <p>Joins any single piece DeVilbiss air cap with latest version MBC-368 or MSA-1 retaining ring. Helps prevent parts loss and provides easier assembly.</p>	<p>KK 5033-57 Air Cap Test Kit</p>  <p>The purpose of this test kit is to measure air cap atomizing air pressure at the center air port of the air cap. Used to confirm code compliance and as a</p>	<p>OMX-70-K48 Paint Cup Liner Kit Allows quick & easy clean-up. Consists of: 1 - Piercing Tool 48 - Disposable Liners 48 - Drain Bushings</p>	<p>29-3100 Scrubs® Hand Cleaner Towels</p>  <p>Scrubs® are a pre-moistened hand cleaner towel for painters. No water is needed.</p>	
<p>Quick Disconnect Approved For HVLP Guns (Air) High Flow Ball and Ring Type.</p>  <p>HC-4419 1/4" NPS(F) HC-4699 1/4" NPT(M) HC-4700 1/4" NPT(F) HC-1166 1/4" NPT(M)</p>				

WARRANTY This product is covered by DeVilbiss' 1 Year Limited Warranty.

DeVilbiss Worldwide Sales and Service Listing: www.devilbiss.com

Industrial Finishing

DeVilbiss has authorized distributors throughout the world. For technical assistance or the distributor nearest you, see listing below.

U.S./Canada Technical Service Office:

195 Internationale Blvd., Glendale Heights, IL 60139
Toll-Free Telephone: 1-888-992-4657 (U.S.A. and Canada only)
Toll-Free Fax: 1-800-368-8401

