

# Binks Model 2001, 2001V AND 2001SS SPRAY GUNS

Your new Binks spray gun is exceptionally rugged in construction, and is built to stand up under hard, continuous use. However, like any other fine precision instrument, its most efficient operation depends on a knowledge of its construction, operation, and maintenance. Properly handled and cared for, it will produce beautiful, uniform finishing results long after other spray guns have worn out.

## TYPES OF INSTALLATION

### SIPHON FEED CUP HOOKUP

Air pressure for atomization is regulated at extractor. The amount of fluid is adjusted by fluid control screw on gun, viscosity of paint, and air pressure (see figure 1).

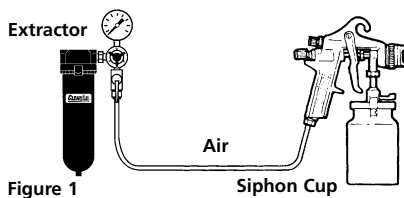

Figure 1

### PRESSURE FEED CUP HOOKUP

For fine finishing with limited spraying.

Air pressure for atomization is regulated at extractor; fluid pressure at cup regulator. For heavy fluids and internal mix nozzle spraying, fluid adjusted by control screw on gun.

Pressure cup also available less regulator (see figure 2).

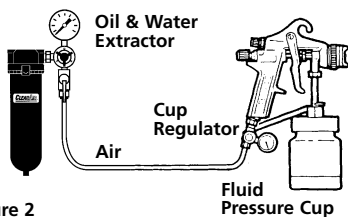

Figure 2

### PRESSURE FEED TANK HOOKUP

For medium production spraying (single regulator).

Air pressure for atomization is regulated at extractor, fluid pressure at tank regulator (see figure 3).

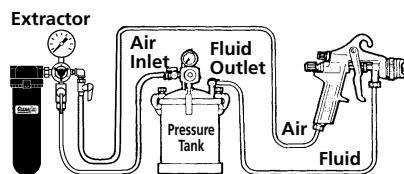
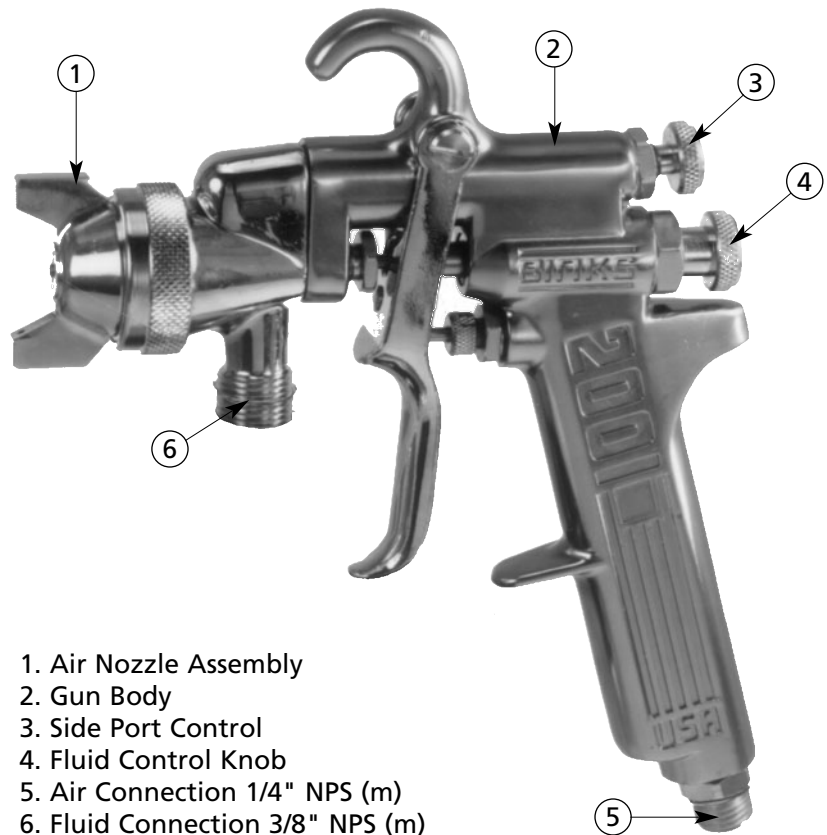

Figure 3



1. Air Nozzle Assembly
2. Gun Body
3. Side Port Control
4. Fluid Control Knob
5. Air Connection 1/4" NPS (m)
6. Fluid Connection 3/8" NPS (m)

### PRESSURE FEED TANK HOOKUP

For portable painting operations (double regulator).

Air pressure for atomization and fluid supply is regulated by two individual air regulators on tank (see figure 4).

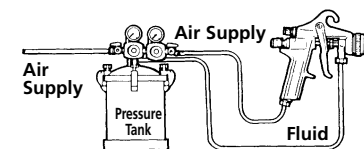

Figure 4

### PRESSURE FEED CIRCULATING HOOKUP

For heavy production spraying.

Air pressure atomization regulated at extractor. Fluid pressure regulated at fluid regulator (see figure 5).

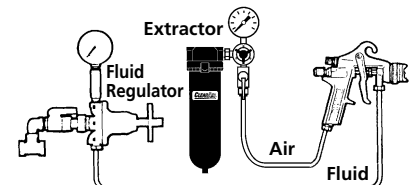

Figure 5

In this part sheet, the words **WARNING**, **CAUTION** and **NOTE** are used to emphasize important safety information as follows:

**⚠ WARNING**  
 Hazards or unsafe practices which could result in severe personal injury, death or substantial property damage.

**⚠ CAUTION**  
 Hazards or unsafe practices which could result in minor personal injury, product or property damage.

**NOTE**  
 Important installation, operation or maintenance information.

**⚠ WARNING**

Read the following warnings before using this equipment.



**READ THE MANUAL**  
 Before operating finishing equipment, read and understand all safety, operation and maintenance information provided in the operation manual.



**WEAR SAFETY GLASSES**  
 Failure to wear safety glasses with side shields could result in serious eye injury or blindness.

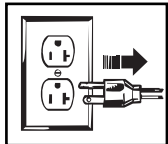

**DE-ENERGIZE, DISCONNECT AND LOCK OUT ALL POWER SOURCES DURING MAINTENANCE**  
 Failure to De-energize, disconnect and lock out all power supplies before performing equipment maintenance could cause serious injury or death.



**OPERATOR TRAINING**  
 All personnel must be trained before operating finishing equipment.



**EQUIPMENT MISUSE HAZARD**  
 Equipment misuse can cause the equipment to rupture, malfunction, or start unexpectedly and result in serious injury.

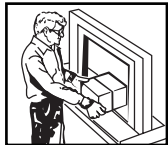

**KEEP EQUIPMENT GUARDS IN PLACE**  
 Do not operate the equipment if the safety devices have been removed.

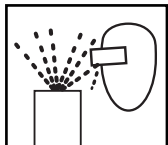

**PROJECTILE HAZARD**  
 You may be injured by venting liquids or gases that are released under pressure, or flying debris.



**PINCH POINT HAZARD**  
 Moving parts can crush and cut. Pinch points are basically any areas where there are moving parts.



**AUTOMATIC EQUIPMENT**  
 Automatic equipment may start suddenly without warning.



**INSPECT THE EQUIPMENT DAILY**  
 Inspect the equipment for worn or broken parts on a daily basis. Do not operate the equipment if you are uncertain about its condition.



**NEVER MODIFY THE EQUIPMENT**  
 Do not modify the equipment unless the manufacturer provides written approval.



**KNOW WHERE AND HOW TO SHUT OFF THE EQUIPMENT IN CASE OF AN EMERGENCY**



**PRESSURE RELIEF PROCEDURE**  
 Always follow the pressure relief procedure in the equipment instruction manual.



**NOISE HAZARD**  
 You may be injured by loud noise. Hearing protection may be required when using this equipment.



**STATIC CHARGE**  
 Fluid may develop a static charge that must be dissipated through proper grounding of the equipment, objects to be sprayed and all other electrically conductive objects in the dispensing area. Improper grounding or sparks can cause a hazardous condition and result in fire, explosion or electric shock and other serious injury.



**FIRE AND EXPLOSION HAZARD**  
 Never use 1,1,1-trichloroethane, methylene chloride, other halogenated hydrocarbon solvents or fluids containing such solvents in equipment with aluminum wetted parts. Such use could result in a serious chemical reaction, with the possibility of explosion. Consult your fluid suppliers to ensure that the fluids being used are compatible with aluminum parts.

**FOR FURTHER SAFETY INFORMATION REGARDING BINKS AND DEVILBISS EQUIPMENT, SEE THE GENERAL EQUIPMENT SAFETY BOOKLET (77-5300).**

## AIR PRESSURE

Atomizing pressure must be set properly to allow for the drop in air pressure between the regulator and the spray gun.

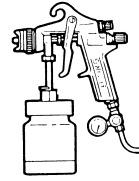
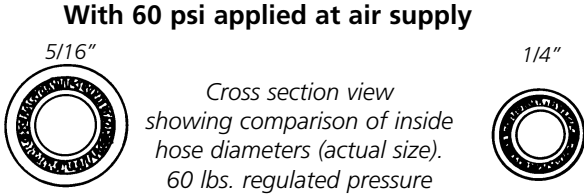

Only 34 PSI at gun inlet  
25 feet of 1/4" I.D. hose causes a drop of 26 PSI between the air supply and the gun.  
**(NOT RECOMMENDED)**

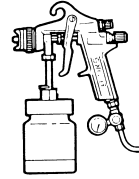

48 PSI at gun inlet  
25 feet of 5/16" I.D. hose causes a drop of 12 PSI between the air supply and the gun. For this reason Binks recommends the use of 5/16" hose.  
**(RECOMMENDED)**

## BINKS OIL AND WATER EXTRACTOR IS IMPORTANT

Achieving a fine spray finish without the use of a good oil and water extractor is virtually impossible.

A Binks regulator / extractor serves a double purpose. It eliminates blistering and spotting by keeping air free of oil and water, and it gives precise air pressure control at the gun.

Binks recommends using Model HFRL-508 Oil and Water Extractor / Regulator. See your local distributor for other models.

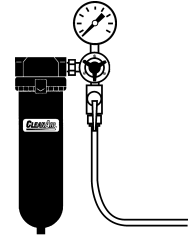

## GUN HANDLING

The first requirement for a good resultant finish is the proper handling of the gun. The gun should be held perpendicular to the surface being covered and moved parallel with it. The stroke should be started before the trigger is pulled and the trigger should be released before the stroke is ended. This gives accurate control of the gun and material.

The distance between gun and surface should be 6 to 12 inches depending on material and atomizing pressure. The material deposited should always be even and wet. Lap each stroke over the preceding stroke to obtain a uniform finish.

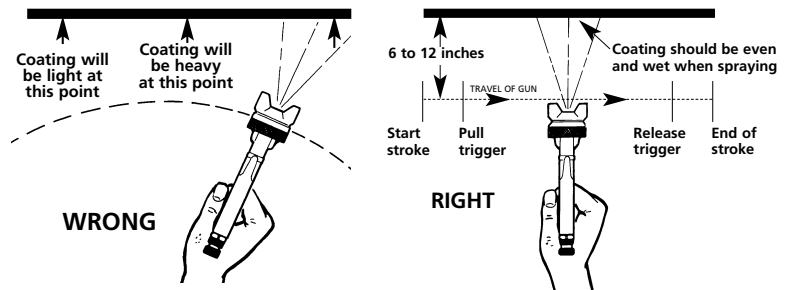

### NOTE

To reduce overspray and obtain maximum efficiency, always spray with the lowest possible atomizing air pressure.

It is extremely poor practice to mount the oil and water extractor on or even near the compressor unit. The temperature of the air is greatly increased as it passes through the compressor and this compressed air must be cooled before the moisture in it will condense. If the air from the compressor is still warm when it passes through the oil and water extractor, moisture will not be effectively removed, but will remain in suspension. Then, when the air cools in the hose beyond the extractor, the moisture will condense into drops of water and cause trouble.

### Air lines must be properly drained

Pitch all air lines back towards the compressor so that condensed moisture will flow back into the air receiver where it can be removed by opening a drain. Every low point on an air line acts as a water trap. Such points should be fitted with an easily accessible drain. See diagram.

## AIR SUPPLY

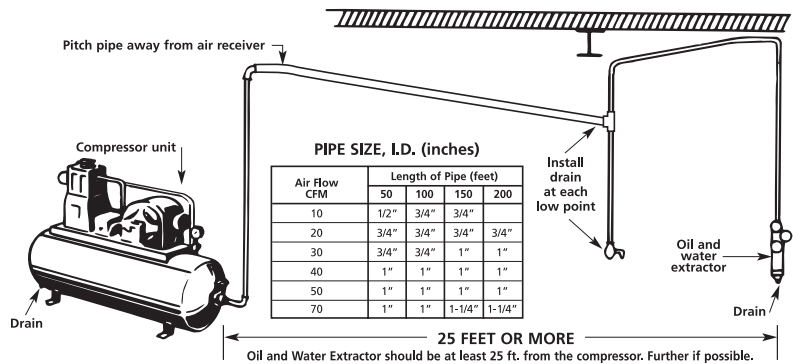

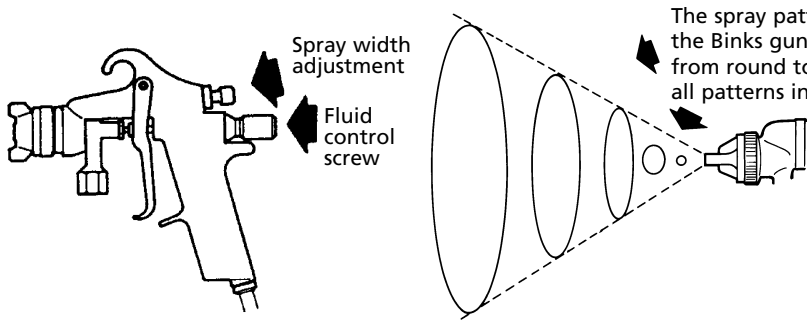

The spray pattern of the Binks gun is variable from round to flat with all patterns in between.

In normal operation, the wings on the nozzle are horizontal as illustrated here. This provides a vertical fan shaped pattern which

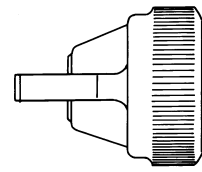

gives maximum coverage as the gun is moved back and forth parallel to the surface being finished.

**Spray width adjustment:** Turn clockwise for round, counterclockwise for fan.

**Fluid control screw:** Turn clockwise to decrease flow, counterclockwise to increase flow.

As width of spray is increased, more material must be allowed to pass through the gun to obtain the same coverage on the increased area.



### SIPHON SPRAYING

Set atomization pressure at approximately 50 PSI for lacquer and 60 PSI for enamel. Test spray. If the spray is too fine, reduce the air pressure or open fluid control screw. If the spray is too coarse, close the fluid control screw. Adjust the pattern width and repeat adjustment of spray if necessary.

### PRESSURE SPRAYING

After selecting correct size fluid orifice, set fluid pressure for desired flow. Open atomization air and test spray. If spray is too fine, reduce air pressure. If spray is too coarse, raise air pressure. Adjust pattern width and repeat adjustment of spray. Keeping fluid control screw in open position will reduce fluid needle wear.

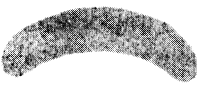
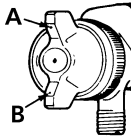
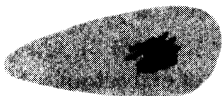
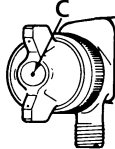
## FAULTY PATTERNS AND HOW TO CORRECT THEM

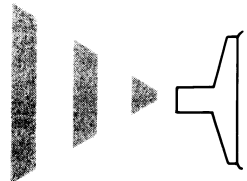
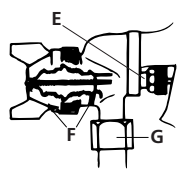
PATTERN	CAUSE	CORRECTION
	Dried material in side-port "A" restricts passage of air. Greater flow of air from cleaner side-port "B" forces fan pattern in direction of clogged side. 	Dissolve material in side-ports with thinner, then blow gun clean. Do not poke into openings with metal instruments.
	Dried material around the outside of the fluid nozzle tip at position "C" restricts the passage of atomizing air at one point through the center opening of air nozzle and results in pattern shown. This pattern can also be caused by a loose air nozzle. 	Remove air nozzle and wipe off fluid tip using rag wet with thinner. Tighten air nozzle.
	A split spray or one that is heavy on each end of a fan pattern and weak in the middle is usually caused by: (1) Too high an atomization air pressure (2) Attempting to get too wide a spray pattern with thin material.	Reducing air pressure will correct cause (1). To correct cause (2), open material control to full position by turning to left. At the same time, turn spray width adjustment to right. This will reduce width of spray, but will correct split spray pattern.
	(1) Dried out packing around material needle valve permits air to get into fluid passageway. This results in spitting. (2) Dirt between fluid nozzle seat and body or loosely installed fluid nozzle will make gun spit. (3) A loose or defective swivel nut on siphon cup or material hose can cause spitting.	 To correct cause (1) back up knurled nut (E), place two drops of machine oil on packing, replace nut and tighten with fingers only. In aggravated cases, replace packing. To correct cause (2), remove fluid nozzle (F), clean back of nozzle and nozzle seat in gun body using rag wet with thinner, replace nozzle and draw up tightly against body. To correct cause (3), tighten or replace swivel nut.

## Binks MODELS 2001, 2001V AND 2001SS SPRAY GUNS – POINTERS ON CLEANING

When used with a cup, thinner or suitable solvent should be siphoned through gun by inserting tube in open container of that liquid. Move trigger constantly to thoroughly flush passageway and to clean tip of needle.

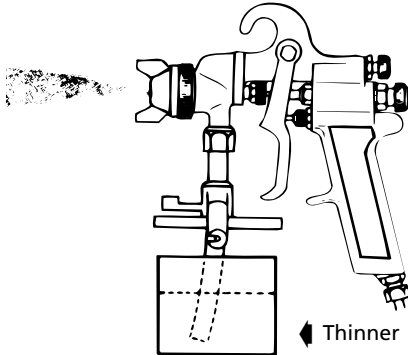

### CLEANING GUN USED WITH PRESSURE TANK

Shut off the air supply to the tank and release the pressure on the tank. Open vent and loosen air nozzle. Hold a piece of cloth, wadded in the hand over the air nozzle and pull the trigger, the air will back up through the fluid nozzle, and force the fluid out of the hose into the tank. Next put enough thinner into the tank to wash the hose and gun thoroughly and spray this through the gun until it is clean. Then blow out the fluid hose to dry it and remove all traces of materials by attaching it to the air line.

### THINNER

Keep thinner level below packing. It is extremely poor practice to place an entire gun in thinner. When this is done, the solvent dissolves the oil in the leather packing and causes the gun to spit. It is good practice to place the nozzle and fluid connection in thinner. Vessel used should be shallow enough to prevent thinner from reaching packing.

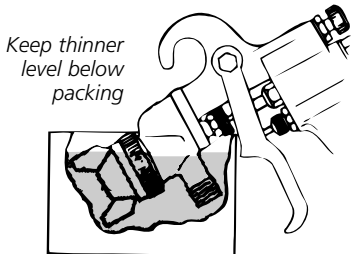

### LUBRICATION

Daily oil fluid needle packing, air valve packing, and trigger bearing screw. Occasionally coat needle valve spring with petroleum jelly. OIL ALL WORKING PARTS EVERY DAY.

**CONTROLLING THE FAN SPRAY:** The fan spray for an external mix nozzle set-up is easily controlled by means of the side port control (28). Turning this control to the right, or clockwise, until it is closed will give a round spray; turning it to the left, or counter-clockwise, will widen the spray into a fan shape of any width desired. The direction of the fan spray, either horizontal or vertical, is obtained by turning the air nozzle to the desired position, then tightening the retainer ring.

### CONTROLLING THE FLUID

If a fluid pressure tank is used, the amount of fluid can be controlled by regulating the pressure on the tank. The amount of fluid can also be controlled by means of the fluid control screw (42). Turning this screw to the right, or clockwise, reduces the amount of fluid; to the left, or counter-clockwise, increases the amount of fluid.

### FAULTY SPRAY

A faulty spray is caused by improper cleaning or dried material around the fluid nozzle tip or in the air nozzle. Soak these parts in a solvent that will soften the dried material and remove with a brush or cloth.

### CAUTION

**Never use metal instruments to clean the air or fluid nozzles. These parts are carefully machined and any damage to them will cause a faulty spray.**

If either the air nozzle or fluid nozzle is damaged, the part must be replaced before a perfect spray can be obtained.

### TO REPLACE THE FLUID PACKING:

Remove the fluid control screw (42), spring (39) and needle. Then remove the fluid packing nut (12) and take out the old packings with a small stiff wire. Replace with new packings (11) oiled lightly and assemble in reverse order. To set packing, insert needle, tighten nut until the needle begins to be too stiff for the spring to move the needle. Then loosen nut 1/2 to 3/4 turn.

### CORRECTING AIR LEAK THROUGH GUN

Air leaking through the gun is caused by the valve stem assembly (6), not seating properly against the valve body (8). Remove the valve body (8) and valve stem assembly (6). Thoroughly clean parts and inspect for damage. Replace worn or damaged parts and assemble in reverse order.

### CORRECTING AIR LEAK AROUND AIR VALVE STEM

Air leaking around the air valve stem (6) may be caused by worn packings (9) or damaged air valve stem (6). Remove trigger (3), packing nut (10) and packings (9). Clean extended portion of air valve stem (6) and inspect for damage; if stem is damaged, replace same as above, insert new packings and assemble in reverse order.

## Binks MODELS 2001, 2001V AND 2001SS SPRAY GUNS – GENERAL MAINTENANCE

### SPRAY GUN

1. Immerse only the front end of the gun until solvent just covers the fluid connection.
2. Use a bristle brush and solvent to wash off accumulated paint.
3. Do not submerge the entire spray gun in solvent because:
  - a. the lubricant in the leather packings will dissolve and the packings will dry out.
  - b. the lubricant at wear surfaces will dissolve causing harder operation and faster wear.
  - c. residue from dirty solvent may clog the narrow air passages in the gun.
4. Wipe down the outside of the gun with solvent-dampened rag.
5. Lubricate gun daily. Use a light machine oil on:
  - a. fluid needle packing.
  - b. air valve packing.
  - c. side port control packing.
  - d. trigger pivot point.Coat the fluid control spring with vaseline.

### CAUTION

Never use lubricants containing silicone. This material may cause finish defects.

### NOTE

All parts on a spray gun should be screwed in hand tight at first; this will avoid the possibility of cross threading the parts. If the parts can not be turned by hand easily, make sure you have the correct parts, unscrew, realign, and try again. NEVER use undue force in mating parts.

### AIR NOZZLE, FLUID NOZZLE, FLUID NEEDLE

1. All nozzles and needles are precision made. They should be handled with care.
2. Do not make any alterations in the gun. To do so could cause finishing difficulties.
3. To clean nozzles, soak them in solvent to dissolve any dried material, then blow them clean with air.
4. Do not probe any of the holes in the nozzles with metal instruments. If probing is necessary, use only a tool that is softer than brass.

## NOZZLE SELECTION

(See chart on page 7)

### A. Material to Be Sprayed

Select the type of fluid you want to spray or a fluid which has the same characteristics as one of those listed.

### B. Method of Feeding Material to the Gun

**Fluid Nozzle**—Consider the speed of application and the viscosity of the fluid to be sprayed. Referring to the *Fluid Nozzle Orifice Size Chart*, those fluid nozzles which can be changed within an air nozzle are indicated.

**Air Nozzle**—Choice is determined by the type of fluid to be sprayed and the volume of air available for the gun.

—External Mix Nozzles, which are generally used, accomplish atomization outside the nozzle. Spray patterns are adjustable from round to fan with all intermediate patterns. (Designated by the letter “E”).

Siphon Type External Mix Nozzles, designated by the letter “S”, will siphon the material from a cup. Used generally for refinishing and touch-up work which does not require large quantities of paint.

Pressure Type External Mix Nozzles, designated by the letter “P”, require pressure to feed the material to the nozzle. A pressure cup, pressure tank or pump is necessary. Used for production work and where large quantities of fluid are handled. This type of nozzle has a greater range of fluid flow and does not limit the size of the paint container.

—Internal Mix Nozzles mix the air and fluid within the air nozzle. The spray pattern is determined by the shape of the nozzle and cannot be changed. Internal mix nozzles require less air and produce slightly less fog. Pressure equipment must be used

with this type of nozzle.

Recommended for maintenance spraying of heavy materials where a fine finish is not required. (Designated by the letter “I”).

### C. Volume of Air (CFM required)

The cubic feet per minute (CFM) listed at 30, 50 and 70 PSI is the actual air used by the air nozzle. Increase of pressure subsequently increases volume of air required by air nozzle, or vice versa. Assume that a compressor will produce 3-5 CFM per horsepower.

### NOTE

The greater the air consumption, the faster the fluid may be applied or the finer a given amount of fluid can be atomized.

## NOZZLE SELECTION CHART

TYPE OF FLUID TO BE SPRAYED	FLUID NOZZLE	AIR NOZZLE	TYPE *	CFM AT			MAX. PAT. (inches) AT 8 in.	FLUID Needle No. ★
				30 PSI	50 PSI	70 PSI		
<b>VERY THIN</b> 14-16 Sec.—No. 2 Zahn Wash Primers, Dyes, Stains, Solvents, Water, Inks	63SS	63P	PE	4.5	7.5	10.0	5.0	563
	63ASS	63P	PE	5.1	8.7	12.2	11.0	563A
	63BSS	63PB	PE	9.0	14.3	20.0	14.0	563A
	66SS	66S	SE	3.4	5.0		9.0	565
	66SS	66SD	SE	7.9	12.1		10.5	565
	66SS	66SK	SE	11.0	15.2	19.5	13.0	565
	63BSS	200	PI	3.1	5.2	6.4	12.0	563A
<b>THIN</b> 16-20 Secs.—No. 2 Zahn Sealers, Primers, Lacquers, Inks, Lubricants Zinc Chromates, Acrylics	63ASS	63P	PE	5.1	8.7	12.2	11.0	563A
	66SS	66SK	SE	11.0	15.2	19.5	13.0	565
	63BSS	200	PI	3.1	5.2	6.4	12.0	563A
	63CSS		PI	3.9	5.5	7.4	9.0	563A
<b>MEDIUM</b> 19-30 Secs.—No. 2 Zahn Lacquers, Syn. Enamels Varnishes, Shellacs, Fillers, Primers, Epoxies, Urethanes Lubricants, Wax Emulsions	63BSS	63PB	PE	9.0	14.3	20.0	14.0	563A
	63CSS	63PR	PE	9.5	15.5	19.5	18.0	563A
	66SS	66SD	SE	7.9	12.0		11.0	565
	66SS	66SK	SE	11.0	15.2	19.5	13.0	565
	63CSS	200	PI	3.1	5.2	6.4	12.0	563A
	66SS		PI	3.9	5.5	7.4	9.0	565
<b>HIGH SOLIDS</b> Enamels	65SS	63PR	PE	9.5	15.5	19.5	18.0	565
<b>HEAVY (CREAM-LIKE)</b> Over 28 Secs.—No. 4 Ford House Paint, Wall Paint (Oil, Latex), Block Sealers, Mill Whites, Vinyls, Acrylics, Epoxies, Gel Coats	67SS	67PB	PE	9.5	14.9	19.5	12.0	567
	68SS	68PB	PE	9.5	14.1	19.1	12.0	568
	67SS	206	PI	6.0	9.5	13.0	15.0	567
	68SS	201	PI	4.6	6.8	9.1	11.0	568
<b>VERY HEAVY</b> Unaggregated, Block Fillers, Textured Coatings, Fire Retardants, Road Marking Paint, Bitumastics, Cellular Plastics, Underbody, Roof Coatings	68SS	68PB	PE	9.5	14.1	19.1	12.0	568
	68SS	206	PI	6.2	9.8	13.2	15.0	568
	59ASS	242	PI	4.1	6.0	8.2	6.0	559
	59ASS	244	PI	7.8	11.5	15.2	12.0	559
	59BSS	250	PI	7.3	11.0	14.7	RD	559
	59BSS	252	PI	7.8	11.5	15.2	6.0	559
	59CSS	262	PI	7.3	11.0	14.7	6.0	559
<b>ADHESIVES</b> Waterbase White Vinyl Glue Solvent Base Neoprenes (Contact Cements)	63CSS	63PB	PE	9.0	14.3	20.0	14.0	563A
	66SS	63PR	PE	9.5	15.5	19.5	15.0	565
	67SS	67PB	PE	9.5	14.1	19.1	12.0	567
	63SS	66SD	PE	7.9	12.1	16.2	4.0	563
	63ASS	66SD	PE	7.9	12.1	16.2	7.0	563A
	66SS	66SD-3	PE	9.5	14.2	19.0	10.0	565
	66SS	66SDJG	PE	10.4			8.0-9.0	565
	66SS	66R	PE/SE		4.2		RD	565
	66	66SDJG	PE	10.4			8.0-9.0	565
	L6SS	66SD-3	PE	9.5	14.2	19.0	10.0	565
	L3BSS	66SD-3	PE	9.5	14.2	19.0	10.0	563A
<b>CERAMICS &amp; SIMILAR ABRASIVE MATERIALS</b> Glazes, Engobes Porcelain Enamel	63CVT	66PH	PE	11.5	16.4	22.0	13.0	563CVT
	64VT	64PA	PE	12.1	15.0	21.0	13.0	564VT
	67VT	67PD	PE	10.0	15.0	20.0	15.0	567VT
	68VT	68PB	PE	9.5	14.1	19.1	12.0	568VT
<b>CONCRETE CURING COMPOUNDS</b>	66SS	200	PI	3.1	5.2	6.4	15.0	565
	67SS	206	PI	6.0	9.5	13.0	18.0	567
	68SS	206	PI	6.2	9.8	13.2	20.0	568
<b>MULTICOLOR PAINTS</b>	66SS	200	PI	3.1	5.2		12.0	565
	67SS	206	PI	6.0	9.5		15.0	567
	66SSxR3		PI		4.2		FAN	565
	66SSxR8		PI		4.2		FAN	565
<b>TEFLONS</b>	63ASS	63PB	PE	9.0	14.3	20.0	10.0	563A
	63BSS	63PR	PE	9.5	15.5	19.5	15.0	563A
	66SS	66SD	SE	7.9	12.1		7.0	565
<b>HAMMERS</b>	63CSS	63PB	PE	9.0	14.3		14.0	563A
	66SS	63PB	PE	9.0	14.3		14.0	565
	66SS	66SD	SE	7.9	12.1		7.0	565
<b>WRINKLE ENAMELS</b>	63CSS	63PB	PE	9.0	14.3	20.0	10.0	563A
	66SS	63PB	PE	9.0	14.3	20.0	10.0	565
<b>ZINC RICH COATINGS</b>	67VT	67PB	PE	9.5	14.1	19.1	12.0	567VT

### FLUID NOZZLE ORIFICE SIZES

59ASS	59BSS	59CSS	+ 63SS	+ 63ASS	+ 63BSS	+ 63CSS	63CVT	64VT	+ 66SS	67SS	67VT	68SS	68VT	794
.171	.218	.281	.028	.040	.046	.052	.052	.064	.070	.086	.086	.110	.110	.040

All air nozzles shown in combination with these (+) fluid nozzles can also be used in combination with any other fluid nozzle marked (+)

\*See text Section B, page 6, for type code. ★All standard needles listed are stainless steel.

## Binks MODELS 2001 AND 2001V SPRAY GUNS

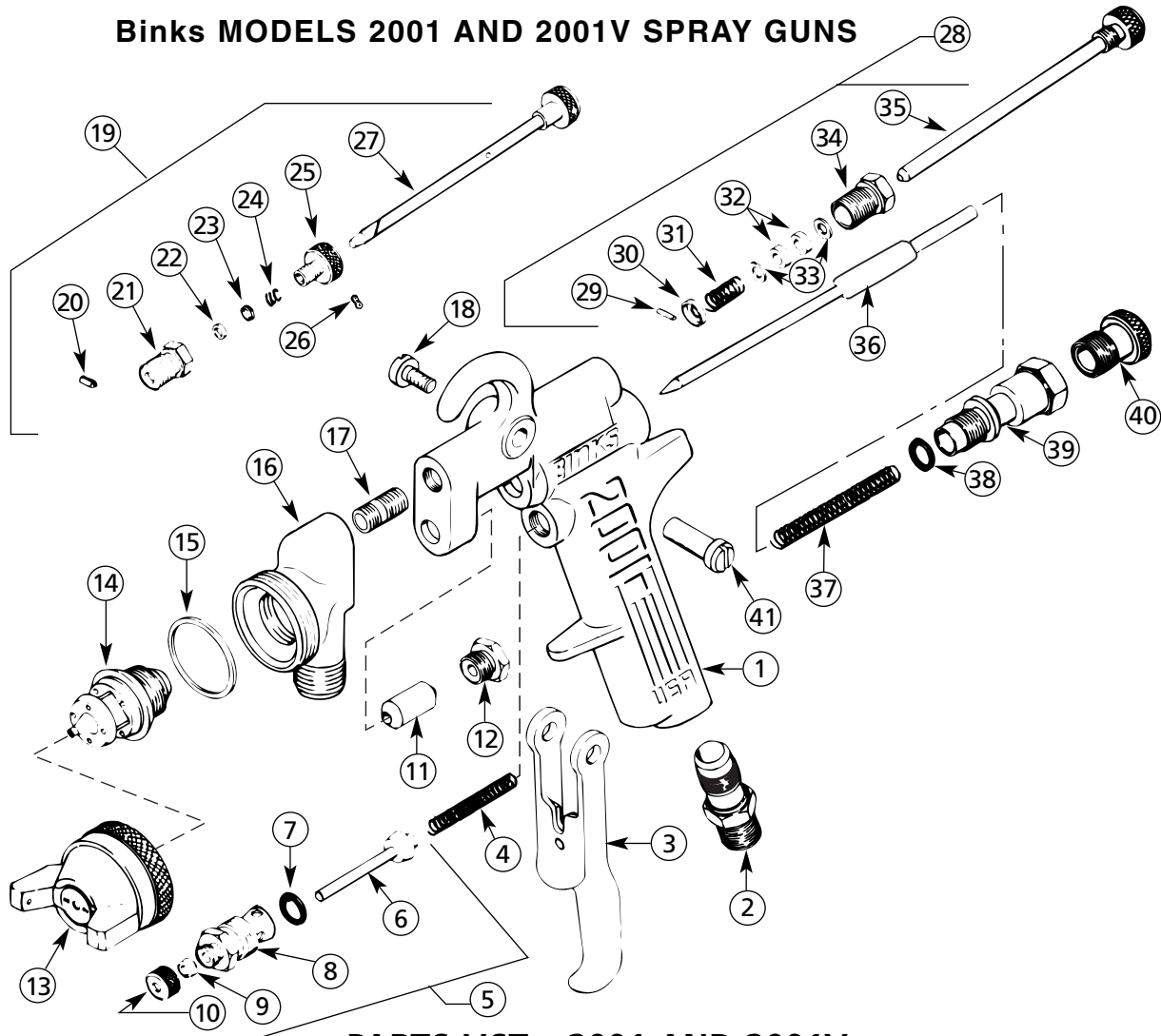

### PARTS LIST – 2001 AND 2001V

When ordering, please specify Part No.

ITEM NO.	PART NO.	DESCRIPTION	QTY.	ITEM NO.	PART NO.	DESCRIPTION	QTY.
1		BODY		22	55-541-5♦★○	PACKING (Optional).....	1
2	54-768	CONNECTION .....	1	23	55-634♦★	RING (Optional) .....	1
3	54-1050★	TRIGGER .....	1	24	54-1804♦★	SPRING (Optional) .....	1
4	54-750-5•○	SPRING .....	1	25	54-1790♦□	SCREW (Optional) .....	1
5	54-1236	AIR VALVE ASSEMBLY .....	1	26	20-3593♦★	SCREW (Optional).....	1
6	54-1025*•	VALVE STEM ASSEMBLY* .....	1	27	54-1789♦	STEM (Order 54-1780).....	1
7	20-3757*•★	O-RING .....	1	28	54-3347	SIDE PORT CONTROL .....	1
8	54-1010★	VALVE BODY .....	1		56-126■	PLUG	
9	82-158-5•★○	PACKING .....	1	29	54-1014-5•○	PIN.....	1
10	82-135-5★○	NUT .....	1	30	54-1015-5★○	WASHER .....	1
11a	54-764-5•○	FLUID PACKING (Standard) .....	1	31	54-304-5•○	SPRING .....	1
11b	2-28-10•‡	TEFLON PACKING (Optional).....	1	32	54-738-5•○	PACKING .....	2
12	56-164	NUT .....	1	33	54-1016-5○	WASHER .....	2
13		AIR NOZZLE* .....	1	34	54-1063	BODY .....	1
14		FLUID NOZZLE* .....	1	35	54-1023	SCREW .....	1
15	54-918-5•★○	GASKET .....	1	36	*	FLUID NEEDLE* .....	1
16	54-3348	HEAD .....	1	37	54-1347-5•✓○	SPRING .....	1
17	54-710	SCREW .....	1	38	20-5285-5•○	O-RING .....	1
18	82-126-5•★○	SCREW .....	1	39	54-1013	BODY .....	1
19	54-1780♦	QUICK CHANGE SIDE PORT CONTROL .....	1	40	54-1007	CONTROL SCREW .....	1
20	84-95♦★	PIN.....	1	41	54-1020•	STUD .....	1
21	54-1794♦□	BODY (Optional) .....	1		5-476	FLUID NOZZLE WRENCH (Optional)**	

\* When ordering, please specify Gun Model No. and number stamped on Nozzle, on Needle Valve Stem, or listed in Nozzle Selection Chart, page 7.

♦ Also available in Repair Kit 6-229.

◆ Not furnished. Please order Assembly 54-1780.

★ Available from Industrial Finishing distributors only.

○ Available only as 5-Pack.

8

‡ Available only as 10-Pack.

□ Not furnished. Can be ordered separately.

■ Replaces 54-3347 Side Port Control when using internal mix nozzles.

✓ Also available: Heavy Duty Spring 54-1372, not furnished. Please order separately.

\*\*Conventional open end or other standard wrenches are not suitable for removing or reinserting the fluid nozzle. Optional Wrench 5-476, available from Binks is recommended.



## Binks MODEL 2001SS SPRAY GUN

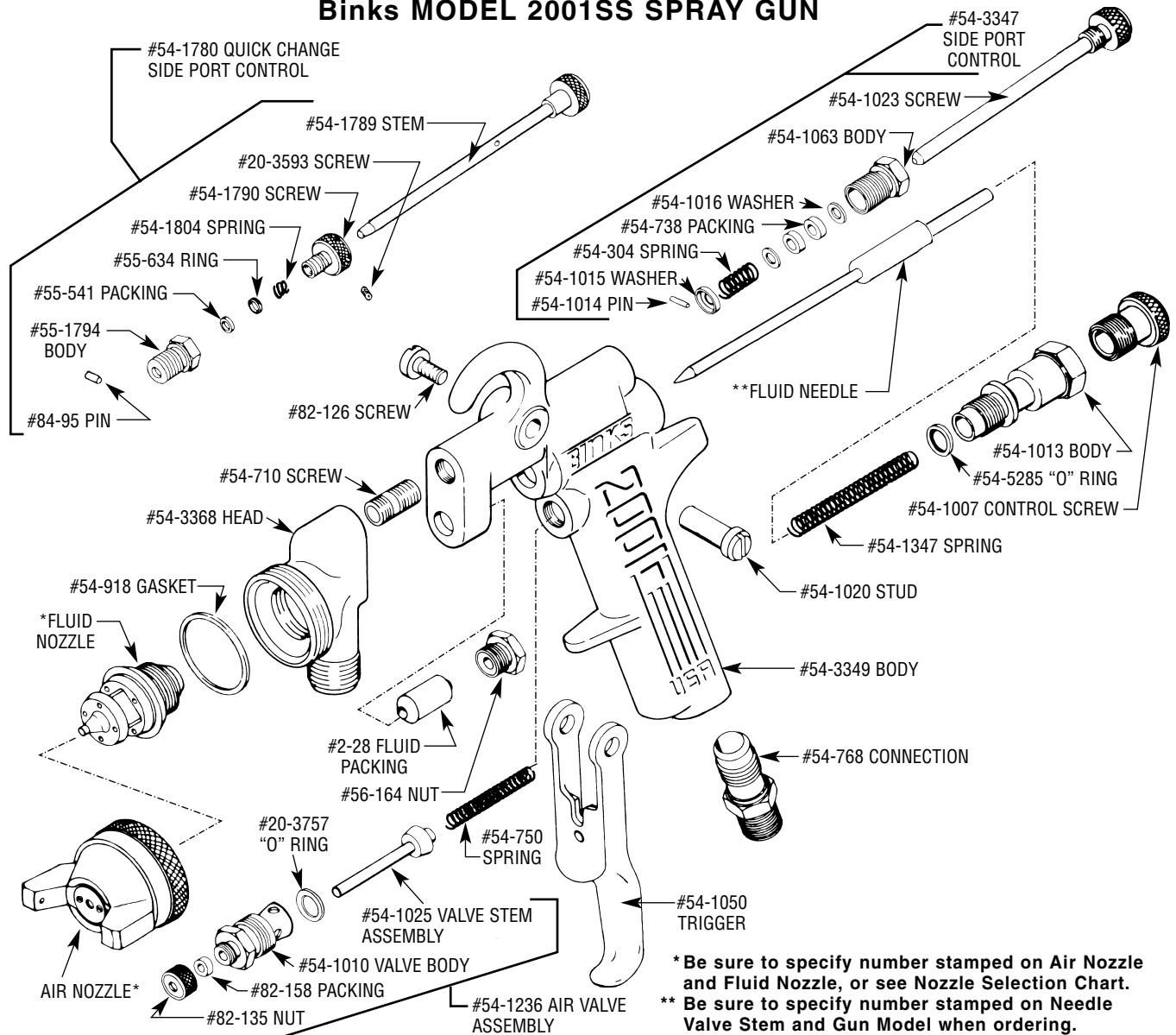

\* Be sure to specify number stamped on Air Nozzle and Fluid Nozzle, or see Nozzle Selection Chart.  
 \*\* Be sure to specify number stamped on Needle Valve Stem and Gun Model when ordering.

### PARTS LIST – 2001SS

When ordering, please specify Part No.

PART NO.	DESCRIPTION	QTY.	PART NO.	DESCRIPTION	QTY.
See Note * Above	AIR NOZZLE .....	1	54-1016	WASHER .....	2
See Note * Above	FLUID NOZZLE .....	1	• 54-1020	STUD .....	1
See Note ** Above	FLUID NEEDLE .....	1	54-1023	SCREW .....	1
• 20-3757	"O" RING .....	1	• 54-1025	VALVE STEM ASSEMBLY .....	1
○ 20-5285-5	"O" RING .....	1	54-1050	TRIGGER .....	1
○ 54-304-5	SPRING .....	1	54-1063	BODY .....	1
54-710	SCREW .....	1	54-1236	AIR VALVE ASSEMBLY .....	1
○ 54-738-5	PACKING .....	2	○ 54-1347-5	SPRING .....	1
○ 54-750-5	SPRING .....	1	* 54-1780	QUICK CHANGE SIDE PORT CONTROL (Optional) .....	1
▲ 2-28-10	FLUID PACKING .....	1	54-3347	SIDE PORT CONTROL .....	1
54-768	CONNECTION .....	1	54-3368	HEAD .....	1
○ 54-918-5	GASKET .....	1	54-3349	BODY (NOT FOR SALE) .....	1
54-1007	CONTROL SCREW .....	1	56-164	NUT .....	1
54-1010	VALVE BODY .....	1	○ 82-126-5	SCREW .....	1
54-1013	BODY .....	1	○ 82-135-5	NUT .....	1
○ 54-1014-5	PIN .....	1	○ 82-158-5	PACKING .....	1
54-1015	WASHER .....	1			

○ Available only as 5-pack  
 • Indicates parts in Repair Kit 6-229  
 ▲ Available only as 10-pack

\* Accessory Item  
 Accessories: 56-126 Plug may replace the 54-3347 Assembly when using internal mix nozzles.

## SPECIAL NOZZLES – INTERNAL MIX HEAVY MATERIAL

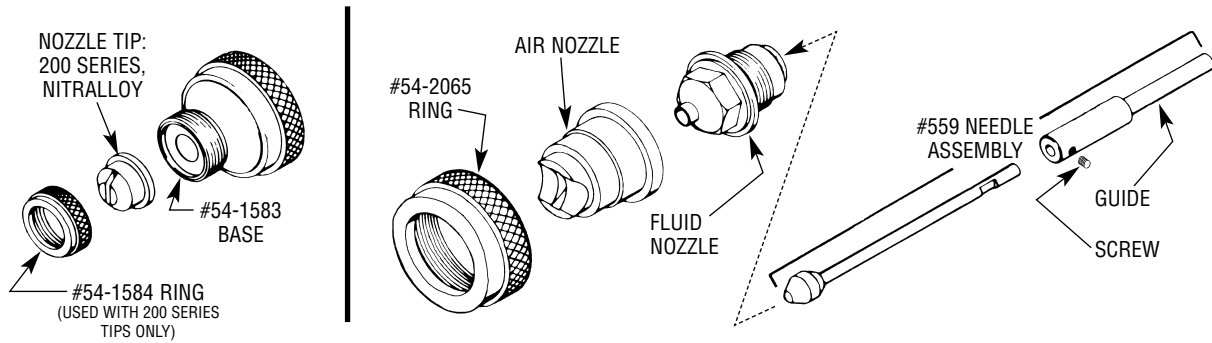

## MULTI-COLOR CONVERSION KIT FOR 60 SERIES NOZZLES

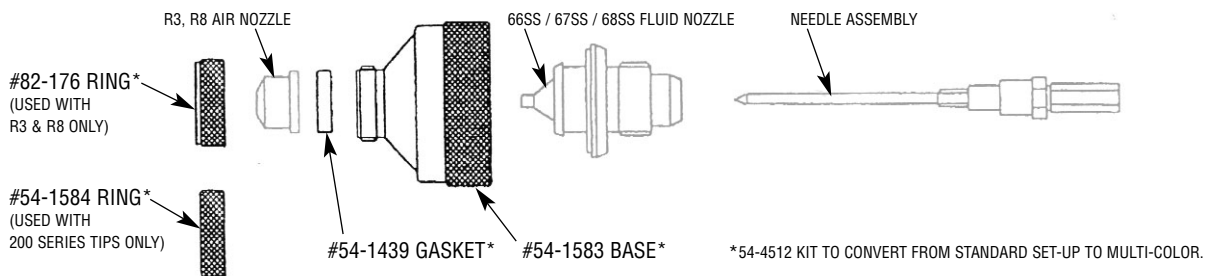

## SPECIAL NOZZLES – SPECIAL EFFECTS

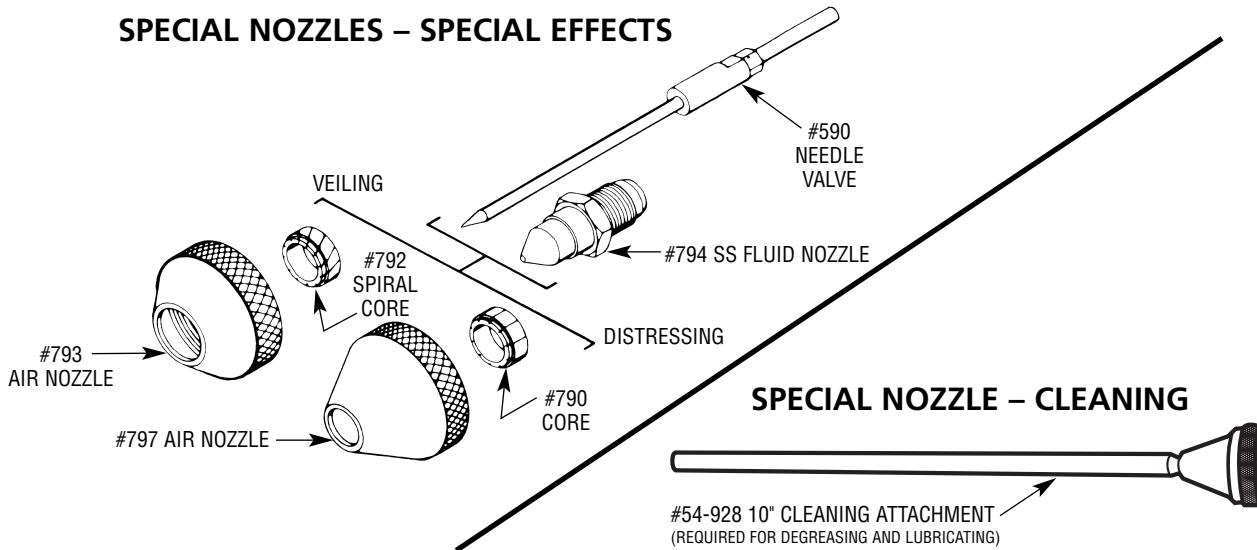

## SPECIAL NOZZLE – CLEANING

SPECIAL EFFECT FINISHES	SOLD ONLY AS ACCESSORIES, ORDER SEPARATELY.				
	Fluid Nozzle	Air Nozzle	Type*	CFM	SS Fluid Needle
VEILING	794	793	PE	3 @ 15 PSI	590
DISTRESS FINISH	794	797	PE	3 @ 15 PSI	590
SPATTER FINISH	66	66PD	PE	3 @ 15 PSI	565

\*See text Section B, page 6, for type code.

NOTES

---

## WARRANTY

This product is covered by Binks' 1 Year Limited Warranty.

**77-2316R-13 Revisions:** Changes throughout to combine 77-2354 (Binks Model 2001SS) with this Part Sheet.

---

**Binks Worldwide Sales and Service Listing: [www.binks.com](http://www.binks.com)**

---

### ITW Industrial Finishing

Binks has authorized distributors throughout the world. For technical assistance or the distributor nearest you, see listing below.

#### U.S./Canada Technical Service Office:

195 Internationale Blvd., Glendale Heights, IL 60139  
Toll-Free Telephone: 1-888-992-4657 (U.S.A. and Canada only)  
Toll-Free Fax: 1-888-246-5732



An Illinois Tool Works Company