

MX1212

12:1 Pump Systems for Air Assist & Airless Finishing

Patent 7,603,855



SPECIFICATIONS

Ratio:	12:1
Maximum air inlet pressure:	8 bar [116 psi]
Maximum fluid pressure:	96 bar [1390 psi]
Displacement per cycle:	72 cc [2.4 oz]
Output @ 60 cycles/min:	4.3 L/m [1.2 gal/m]
Air consumption @ 20 cycles/min:	147 LPM [5.2 SCFM]
Maximum recommended continuous cycle rate:	20 cycles/min
Air inlet connection:	3/8" BSP(f) and 1/4" NPS(m)
Air piston diameter:	85 mm [3.3 in]
Stroke length:	75 mm [3.0 in]
Fluid inlet connection:	3/4" NPS(m)
Fluid outlet connection:	3/8" BSP(m) / 3/8" NPS(m)
Wetted parts materials of construction:	Stainless Steel, Tungsten Carbide, Hard Chrome, PTFE, Polyethylene, Leather
Sound level:	96.2 dB

We reserve the right to change the specifications without prior notice.

In this part sheet, the words **WARNING**, **CAUTION** and **NOTE** are used to emphasize important safety information as follows:

⚠ WARNING
 Hazards or unsafe practices which could result in severe personal injury, death or substantial property damage.

⚠ CAUTION
 Hazards or unsafe practices which could result in minor personal injury, product or property damage.

NOTE
 Important installation, operation or maintenance information.

⚠ WARNING

Read the following warnings before using this equipment.



READ THE MANUAL
 Before operating finishing equipment, read and understand all safety, operation and maintenance information provided in the operation manual.



WEAR SAFETY GLASSES
 Failure to wear safety glasses with side shields could result in serious eye injury or blindness.



DE-ENERGIZE, DEPRESSURIZE, DISCONNECT AND LOCK OUT ALL POWER SOURCES DURING MAINTENANCE
 Failure to De-energize, disconnect and lock out all power supplies before performing equipment maintenance could cause serious injury or death.



OPERATOR TRAINING
 All personnel must be trained before operating finishing equipment.



EQUIPMENT MISUSE HAZARD
 Equipment misuse can cause the equipment to rupture, malfunction, or start unexpectedly and result in serious injury.



KEEP EQUIPMENT GUARDS IN PLACE
 Do not operate the equipment if the safety devices have been removed.

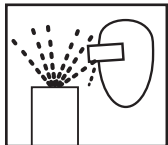

PROJECTILE HAZARD
 You may be injured by venting liquids or gases that are released under pressure, or flying debris.



PINCH POINT HAZARD
 Moving parts can crush and cut. Pinch points are basically any areas where there are moving parts.



PACEMAKER WARNING
 You are in the presence of magnetic fields which may interfere with the operation of certain pacemakers.



AUTOMATIC EQUIPMENT
 Automatic equipment may start suddenly without warning.



INSPECT THE EQUIPMENT DAILY
 Inspect the equipment for worn or broken parts on a daily basis. Do not operate the equipment if you are uncertain about its condition.



NEVER MODIFY THE EQUIPMENT
 Do not modify the equipment unless the manufacturer provides written approval.



KNOW WHERE AND HOW TO SHUT OFF THE EQUIPMENT IN CASE OF AN EMERGENCY



PRESSURE RELIEF PROCEDURE
 Always follow the pressure relief procedure in the equipment instruction manual.



NOISE LEVELS
 The A-Weighted sound level of pumping equipment and spray guns may exceed 85 dB (A) depending on the set-up being used. Details of actual noise levels are available on request. It is recommended that ear protection is worn at all times when spraying while pump is operating.



HIGH PRESSURE CONSIDERATION
 High pressure can cause serious injury. Relieve all pressure before servicing. Spray from the spray gun, hose leaks, or ruptured components can inject fluid into your body and cause extremely serious injury.



STATIC CHARGE
 Fluid may develop a static charge that must be dissipated through proper grounding of the equipment, objects to be sprayed and all other electrically conductive objects in the dispensing area. Improper grounding or sparks can cause a hazardous condition and result in fire, explosion or electric shock and other serious injury.

IT IS THE RESPONSIBILITY OF THE EMPLOYER TO PROVIDE THIS INFORMATION TO THE OPERATOR OF THE EQUIPMENT.

FOR FURTHER SAFETY INFORMATION REGARDING BINKS AND DEVILBISS EQUIPMENT, SEE THE GENERAL EQUIPMENT SAFETY BOOKLET (77-5300).

! WARNING



HIGH PRESSURE CAN CAUSE SERIOUS INJURY IF EQUIPMENT IS INSTALLED OR USED INCORRECTLY—READ, UNDERSTAND, AND OBSERVE ALL WARNINGS AND INSTRUCTIONS IN THIS MANUAL.

INSTALL, OPERATE OR SERVICE THIS EQUIPMENT ONLY AFTER ALL INSTRUCTIONS ARE CLEARLY UNDERSTOOD.

It is the responsibility of the employer to place this information into the hands of the operator.

! WARNING
Hazards or unsafe practices which could result in severe personal injury, death or substantial property damage.

! CAUTION
Hazards or unsafe practices which could result in minor personal injury, product or property damage.

NOTE
Important installation, operation or maintenance information.

AVOID STATIC SPARKING

1. Use Binks **NO-WIRE** conductive hose in all airless spraying operations. Be sure the gun and hose have continuity.
2. Make sure the pump is grounded. **NEVER** operate the unit when it is on a non-grounded platform.
3. When flushing or cleaning with a combustible solvent, always use an open metallic container for receiving the waste solvent. Ground the solvent receptacle.
4. **ALWAYS** remove spray tip when flushing the system. Operate the pump at the lowest possible pressure.

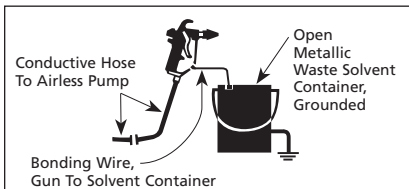

GENERAL WARNINGS

1. **NEVER** leave a pressurized sprayer unattended.
2. Periodically inspect all hoses for leaks and/or abrasions and tighten all connections before use. **DO NOT ATTEMPT TO REPAIR** a defective hose. **REPLACE** it with another conductive hose.
3. **ALWAYS** relieve pressure in the system by turning bypass valve to **BYPASS** or triggering spray gun before disassembly of any component parts.

CAUTION
Never store de-ionized, distilled, reverse osmosis or any pure grade of water in the pump. These fluids may cause corrosion.

NOTE
BINKS is not responsible for misapplication of pumps. Consult your BINKS representative for application assistance.

NOTE
Be sure that all fluids, solvents and fillers to be used are chemically and physically compatible with wetted parts in the pump. Consult your BINKS representative for pump materials of constructions and compatibility information. Consult the fluid manufacture for information regarding the fluids to be used.

REPLACEMENT PARTS

The pump is designed to use authorized parts only. When using this pump with parts that do not comply with the minimum specifications and safety devices of Binks, the user assumes all risks and liabilities.

! WARNING
EXCESSIVE AIR PRESSURE Can cause personal injury, pump damage or property damage. Do not exceed maximum inlet air pressure as stated on motor model plate.

HAZARD	CAUSE	SAFEGUARDS
<p>EXPLOSION</p> 	<p>STATIC ELECTRICITY</p> <p>Use of this equipment in a potentially explosive atmosphere.</p> <p>Vapors from flammable liquids can catch fire or explode from static electricity discharges.</p>	<ol style="list-style-type: none"> 1. If installing this equipment in a potentially explosive atmosphere, check the ATEX equipment category and temperature ratings meet the requirements for the zoned area. 2. Check electrical continuity of the air supply to earth — should be no greater than $10^6 \Omega$. 3. Electrically bond all metallic equipment to earth. Should be no greater than 1Ω.
<p>SPECIAL CONDITIONS FOR SAFE USE REQUIRED BY ATEX CERTIFICATION</p>	<p>Over pressurization of equipment can cause equipment failure or injury.</p> <p>Use lubricating medium resistant to carburisation.</p> <p>Improper operation or maintenance may create a hazard.</p>	<ol style="list-style-type: none"> 1. Do not exceed the stated maximum working pressures and motor speed as specified in this manual. 2. Only a suitably approved static dissipating or conductive air supply hoses shall be attached to the equipment and terminated to the air supply. 3. Air supplies (compressors, etc.) shall be sited in a non-hazardous area with a filter on the air intake system to prevent the ingress of dust or similar foreign material into the parts where compression takes place. 4. Use lubricating medium resistant to carburisation and has an auto ignition temperature of more than 185°C for T4 equipment. 5. User shall ensure all metallic parts of the equipment are suitably bonded to earth. Should be no greater than 1Ω.

EC Declaration of Conformity



We: ITW Finishing UK, Ringwood Rd., Bournemouth, Dorset, BH11 9LH, UK

As the manufacturer of the items listed below:

Piston Pumps MX412 MX432 MX1212 MX1231

Declare, under our sole responsibility, that, the equipment to which this document relates is in conformity with the following standards or other normative documents:

EN 13463-1:2009, EN 13463-5:2005, EN 982:1996 + A1:2008, EN 983:1996 + A1:2008 and EN 12621:2006

And thereby conform to the protection requirements of Council Directive 98/37/EC relating to **Machinery Safety Directive** and council Directive 94/9/EC relating to **Equipment and Protective Systems intended for use in Potentially Explosive Atmospheres**;

CE Ex 2 II Gc T4

Issued on: 1st July 2009

Authorized by:



General Manager

Technical file lodged with;
 TRL Compliance Ltd (Notified Body 0891)
 Moss View
 Nipe Lane
 Up Holland
 WN8 9PY, UK

STARTUP AND OPERATION

(Part numbers referenced are contained in the MX1212 bare pump assemblies part sheet: 77-2926.)

GROUNDING THE BINKS PUMP

⚠ WARNING

To prevent static charging igniting the flammable spray material, the BINKS pump must be grounded before it is started up. A grounding cable is included with the pump.

1. Clamp the grounding cable to the terminal on the high pressure filter or the air motor.
2. Connect the other end of the grounding cable to a suitable grounding device (e.g. grounding bar).

PREPARING TO START UP THE BINKS PUMP

Proceed as follows:

1. Check that the solvent cup is full to the level shown. If necessary, add material to the solvent cup. (Order part no. 0114-009433 for solvent based paint, and part no. 0114-014871 for waterborne paint.)



2. Select a suitable filter element using the table in this manual (page 9) and insert it into the high pressure filter (0115-010326).
3. Attach a suitable fluid hose to the outlet fitting (0114-016059) on the high pressure filter (0110-009130).

⚠ WARNING

The fluid hose supplied by BINKS is identified with the maximum permitted working pressure and the bursting pressure. The lesser value—the maximum permitted working pressure—must be greater than the maximum permitted working pressure of the pump.

4. Connect the gun—designed at least for the maximum permitted working pressure of the pump—to the fluid hose.
5. Make sure that the ball valve on the air control assembly is closed.
6. Connect the compressed air supply to the air inlet connection.
7. The pump is equipped with an air pressure regulator (0115-010183). Before putting the pressure line into operation, relieve the pressure

regulator by fully unscrewing the regulating screw. Thereafter rotate the regulating screw clockwise until the pressure gauge (0115-010192) on the regulator indicates the required pressure.

NOTE

The pump is equipped with an air pressure safety valve (0114-014774) set at 8 bar (116 psi).

RINSING THE BINKS PUMP

⚠ WARNING

Wear eye protection.

Every BINKS pump is tested with water during final inspection and thoroughly rinsed with a non-gumming preservative oil. With this rinsing process, it is possible that the residual moisture of water emulsion will be left in the pump.

Before the unit is started up for the first time, a suitable solvent must be used to thoroughly rinse out the remains of the preservative fluid and the unavoidable impurities introduced during equipment assembly.

Proceed as follows:

1. Prepare the BINKS pump for start-up as shown above.
2. Close the high pressure ball valve (0114-019091) on the fluid filter.
3. Immerse the suction system in the tank of solvent.
4. Insert the return flow hose (0114-009103) into the tank of solvent. Open the high pressure ball valve (0114-019091) on the fluid filter.
5. Open the ball valve and set the air regulator (0115-010183) to approximately 1 bar (14.5 psi). The suction system now draws in the solvent. The solvent runs back to the solvent tank through the high pressure filter (0110-009130), the high pressure ball valve (0114-019091) and the return flow hose (0110-009103).
6. Remove the spray tip from the gun and point the gun into the tank. Unlock the safety lever on the gun, operate the gun and close the high pressure ball valve. The solvent will now flow through the high pressure filter, the fluid hose and the gun, back into the tank. The time of rinsing depends on

the length of the material lines and the solubility of the spray material. We recommend a short reflush with "fresh" solvent.

7. Release the gun trigger.
8. Slowly increase the pressure at the regulator to maximum working pressure while checking and testing that all lines and screw and plug caps are tightly sealed. If there are any leaks in the system, shut down the BINKS pump immediately. Only restart the BINKS pump once you have repaired the leak.
9. Reduce the air pressure at the air regulator (0115-010183) again and close the ball valve.
10. Make sure that the return flow hose (0110-009103) is still directed into the solvent tank. Carefully open the high pressure ball valve (0114-019091) to reduce the pressure in the fluid hose and in the high pressure filter.
11. Point the gun into the tank of solvent and operate the trigger, to reduce any pressure which may still exist in the fluid hose and in the gun.

⚠ CAUTION

If working with waterborne material, the BINKS pump must again be thoroughly rinsed with water before it is started up.

START-UP

1. Prepare the BINKS pump for start-up as shown above and if necessary, rinse pump.
2. Close the high pressure ball valve (0114-019091) on the fluid filter.
3. Immerse the suction system in the spray material to be used.
4. Place the return flow hose (0110-009103) in the tank. Then open the high pressure ball valve (0114-019091).
5. Open the ball valve for the compressed air supply and use the pressure regulator (0115-010183) to set the compressed air supply to 1 bar (14.5 psi). The pump will now draw in the spray material. The spray material flows back into the tank through the high pressure filter, the high pressure ball valve and the return pipe.

(continued on next page)

STARTUP AND OPERATION

6. Remove the spray tip from the gun and point the gun into the tank. Unlock the safety lever on the gun. Operate the gun trigger and close the high pressure ball valve (0114-019091). The spray material will now flow through the high pressure filter, the fluid hose and the gun, back into the tank.
7. Release the gun trigger and set the working pressure at the regulator.

NOTE

Before carrying out any coating work, we recommend a test spray (e.g. on to paper or wood). Only if the test gives you the desired result should you start to coat the actual object.

WORK STOPPAGES

CAUTION

If working with 2-K spray material, you must note the given pot life and follow it precisely. Within this time, the unit must be carefully cleaned and rinsed with the recommended solvent. There must be no residue left in the pump, the high pressure filter or the gun.

CAUTION

When work is stopped, the safety lever of the gun must be locked.

For work stoppages of between 10 and 30 minutes, please proceed as follows:

WARNING

Wear eye protection.

1. Lock the safety lever on the gun.
2. Shut off the compressed air supply by closing the ball valve.
3. Briefly open the high pressure ball valve (0114-019091), taking care that the return flow hose (0110-009103) is not pointed at other people or at yourself, until the pressure has reduced. Then close the high pressure ball valve again.
4. Clean the outside of the spray nozzle from spray material residue.

SHUT-DOWN

CAUTION

Once work is completed, the BINKS pump must be thoroughly cleaned. Under no circumstances must you allow paint residue to dry out in the unit. To clean the pump, use a solvent appropriate to the spray material.

WARNING

Wear eye protection.

1. Close the ball valve for the compressed air supply.
2. Make sure that the flow hose (0110-009103) is still directed into the spray material tank. Carefully open the high pressure ball valve (0114-019091) to reduce the pressure in the pump and in the high pressure filter.
3. Remove the spray tip from the gun.
4. Point the gun into the tank of spray material and operate the trigger to reduce any pressure which may still exist in the fluid hose and in the gun.
5. Lock the safety lever on the gun.
6. Remove the suction system from the spray material.

CLEANING YOUR BINKS PUMP

CAUTION

Do not allow spray material or solvent to soak into the ground.

WARNING

Wear eye protection.

1. Clean the pump and the suction system from the outside. Immerse the suction system in the tank of solvent.
2. Clean the fluid tip/tip system as described in the service bulletin of the spray gun. We recommend to soak the fluid tip in solvent.
3. Unlock the safety lever of the gun without fluid tip. Operate the gun. Close the high pressure ball valve (0114-01909). Set the air inlet pressure to 1 bar (14.5 psi) and slowly open the ball valve. Let the solvent run through the system so that the spraying material can rinse out.
4. Let the solvent run through the system for a couple of minutes until the solvent runs clear through the gun. Close the ball valve and lock the safety lever of the gun
5. Clean the gun from the outside and check the filter on the handle (if mounted).
6. Clean the filter element of the high pressure filter.
7. Clean the filter of the suction system.
8. We recommend keeping the pump filled with liquid.

NOTE

If the pump is not to be used for longer periods of time, we recommend flushing the system with a light, silicone-free oil.

MX1212 CART MOUNTED ASSEMBLIES

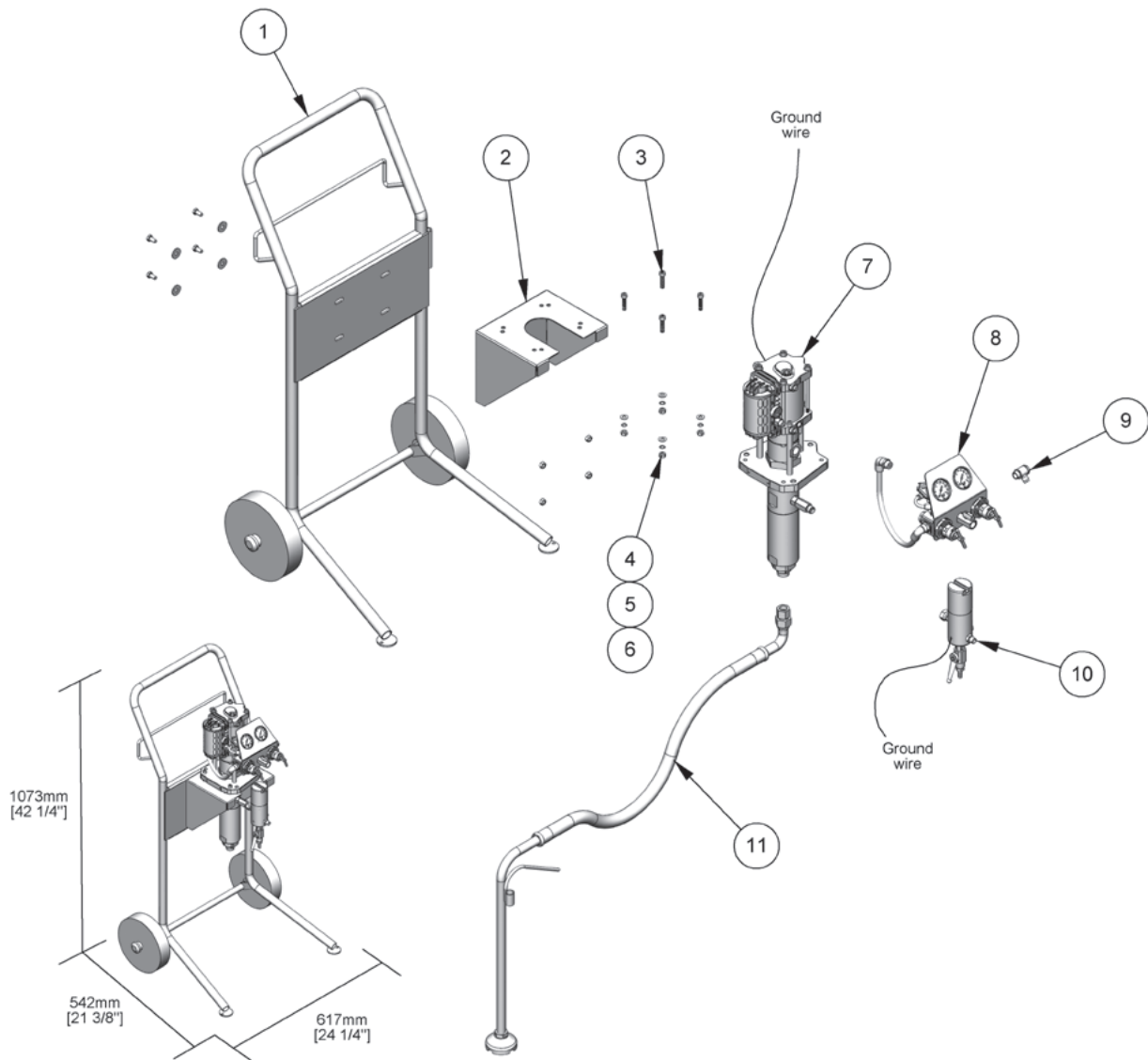

SYSTEM COMPONENTS LIST

ITEM NO.	PART NUMBER	DESCRIPTION	0015-1212F-AC	0015-1212F-AC-P	0015-1212F-AC-PU	0015-1212F-AL	0015-1212F-AL-P	0015-1212F-AL-PU	SERVICE BULLETIN
1	0115-010186	TROLLEY ASSEMBLY	1	1	1	1	1	1	
2	0115-010179	WALL BRACKET	1	1	1	1	1	1	
3	0115-010001	SOCKET HEAD CAP SCREW	4	4	4	4	4	4	
4	0115-010030	HEX NUT	4	4	4	4	4	4	
5	0115-010031	LOCKWASHER	4	4	4	4	4	4	
6	0115-010035	PLAIN WASHER	4	4	4	4	4	4	
7	MX1212PL	MX1212 BARE PUMP ASSEMBLY (PTFE/Leather)	1	0	0	1	0	0	77-2926
	MX1212PP	MX1212 BARE PUMP ASSEMBLY (PTFE)	0	1	0	0	1	0	77-2926
	MX1212PU	MX1212 BARE PUMP ASSEMBLY (PTFE/UHMW)	0	0	1	0	0	1	77-2926
8	0115-010180	AIR ASSIST AIR CONTROL	1	1	1	0	0	0	
	0115-010198	AIRLESS AIR CONTROL	0	0	0	1	1	1	
9	0114-009164	ELBOW FITTING	1	1	1	0	0	0	
10	0110-009130	HP FILTER ASSEMBLY (100 mesh)	1	1	1	1	1	1	
11	0115-010236	SUCTION HOSE ASSEMBLY (20 mesh)	1	1	1	1	1	1	

MX1212 WALL MOUNTED ASSEMBLIES

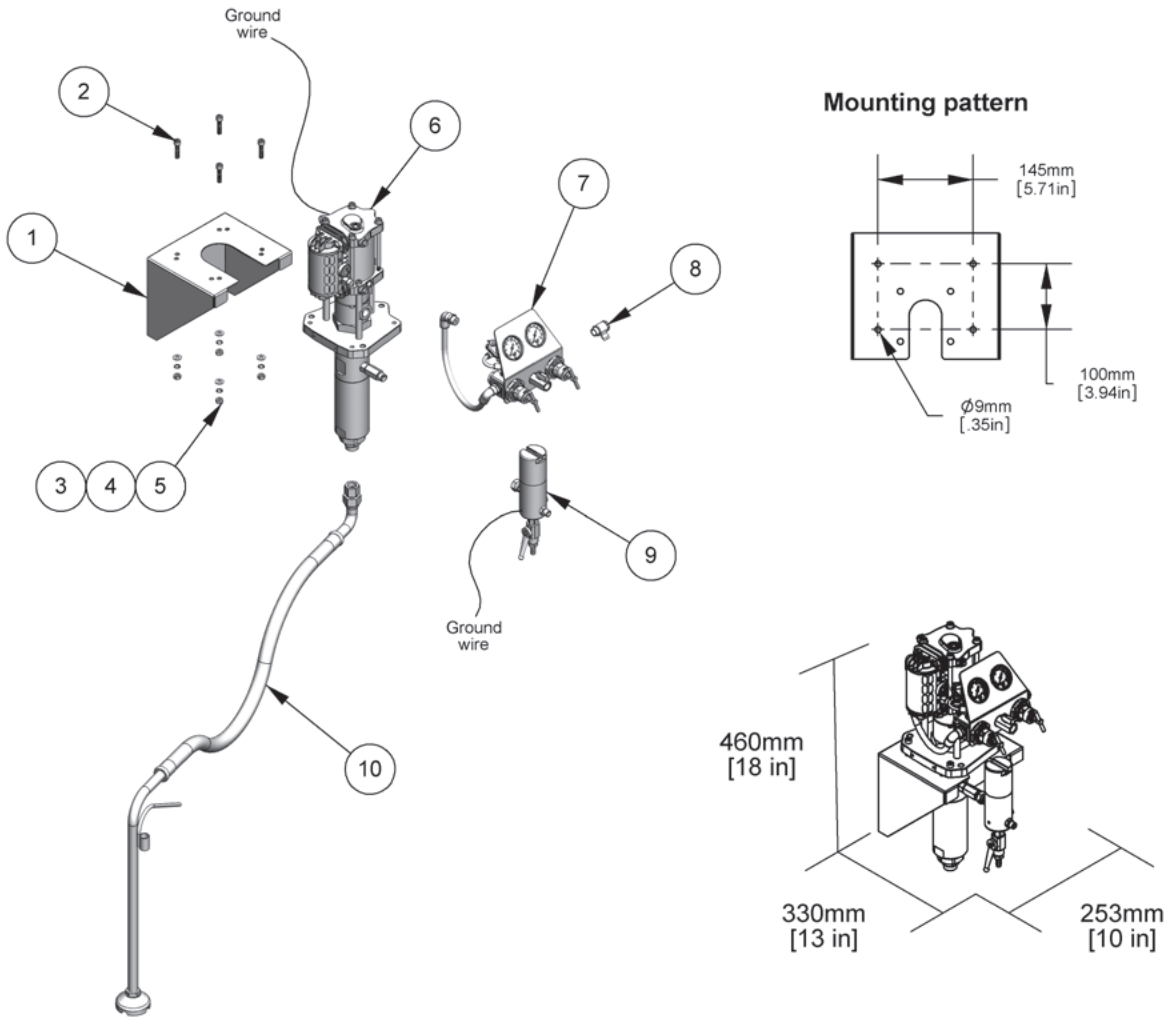

SYSTEM COMPONENTS LIST

ITEM NO.	PART NUMBER	DESCRIPTION	0015-1212W-AC	0015-1212W-AC-P	0015-1212W-AC-PU	0015-1212W-AL	0015-1212W-AL-P	0015-1212W-AL-PU	SERVICE BULLETIN
1	0115-010179	WALL BRACKET	1	1	1	1	1	1	
2	0115-010001	SOCKET HEAD CAP SCREW	4	4	4	4	4	4	
3	0115-010030	HEX NUT	4	4	4	4	4	4	
4	0115-010031	LOCKWASHER	4	4	4	4	4	4	
5	0115-010035	PLAIN WASHER	4	4	4	4	4	4	
6	MX1212PL	MX1212 BARE PUMP ASSEMBLY (PTFE/Leather)	1	0	0	1	0	0	77-2926
	MX1212PP	MX1212 BARE PUMP ASSEMBLY (PTFE)	0	1	0	0	1	0	77-2926
	MX1212PU	MX1212 BARE PUMP ASSEMBLY (PTFE/UHMW)	0	0	1	0	0	1	77-2926
7	0115-010180	AIR ASSIST AIR CONTROL	1	1	1	0	0	0	
	0115-010198	AIRLESS AIR CONTROL	0	0	0	1	1	1	
8	0114-009164	ELBOW FITTING	1	1	1	0	0	0	
9	0110-009130	HP FILTER ASSEMBLY (100 mesh)	1	1	1	1	1	1	
10	0115-010236	SUCTION HOSE ASSEMBLY (20 mesh)	1	1	1	1	1	1	

0110-009130 HIGH PRESSURE FILTER ASSEMBLY (100 MESH FILTER ELEMENT)

SPECIFICATIONS	
Max working pressure:	500 bar [7200 psi]
Fluid inlet connection:	3/8" BSP (f)
Fluid outlet connection:	1/4" NPS (m)
Wetted parts materials of construction:	Stainless Steel, PTFE

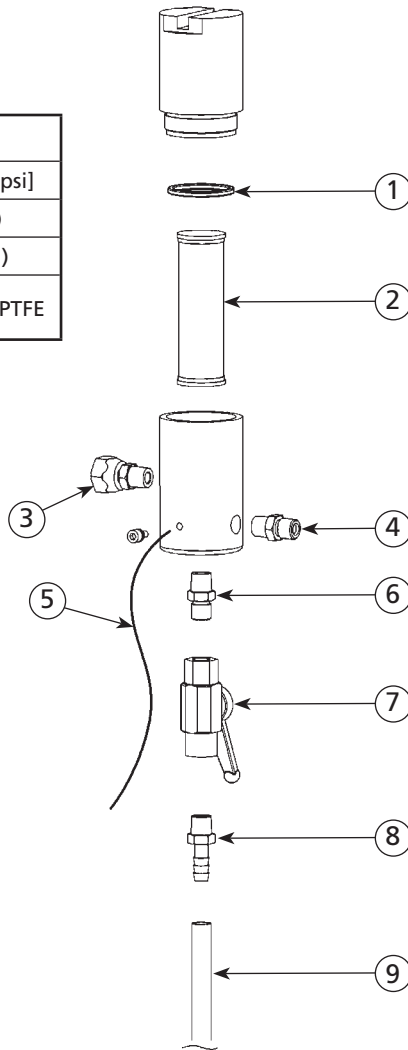

PARTS LIST

When ordering, please specify Part No.

ITEM NO.	PART NO.	DESCRIPTION	QTY.
1	0114-016061	GASKET	1
2	0110-009132	100-MESH FILTER ELEMENT	1
3	0110-016058	INLET SWIVEL FITTING, 3/8 BSPT(M) x 3/8 BSPP(F)..	1
4	0114-016059	OUTLET FITTING, 1/4 NPT(M) x 1/4 NPS(M)	1
5	0114-016243	GROUNDING WIRE KIT	1
6	0114-019090	OUTFLOW FITTING	1
7	0114-019091	HIGH PRESSURE BALL VALVE	1
8	0114-019092	HOSE NIPPLE.....	1
9	0110-009103	RETURN FLOW HOSE, 3/8 ID x 1/2 OD.....	1

Additional filter mesh sizes (sold separately):

0110-009131 50 mesh
0010-009133 150 mesh
0010-009060 200 mesh

0115-010180 AIR ASSIST AIR CONTROL ASSEMBLY

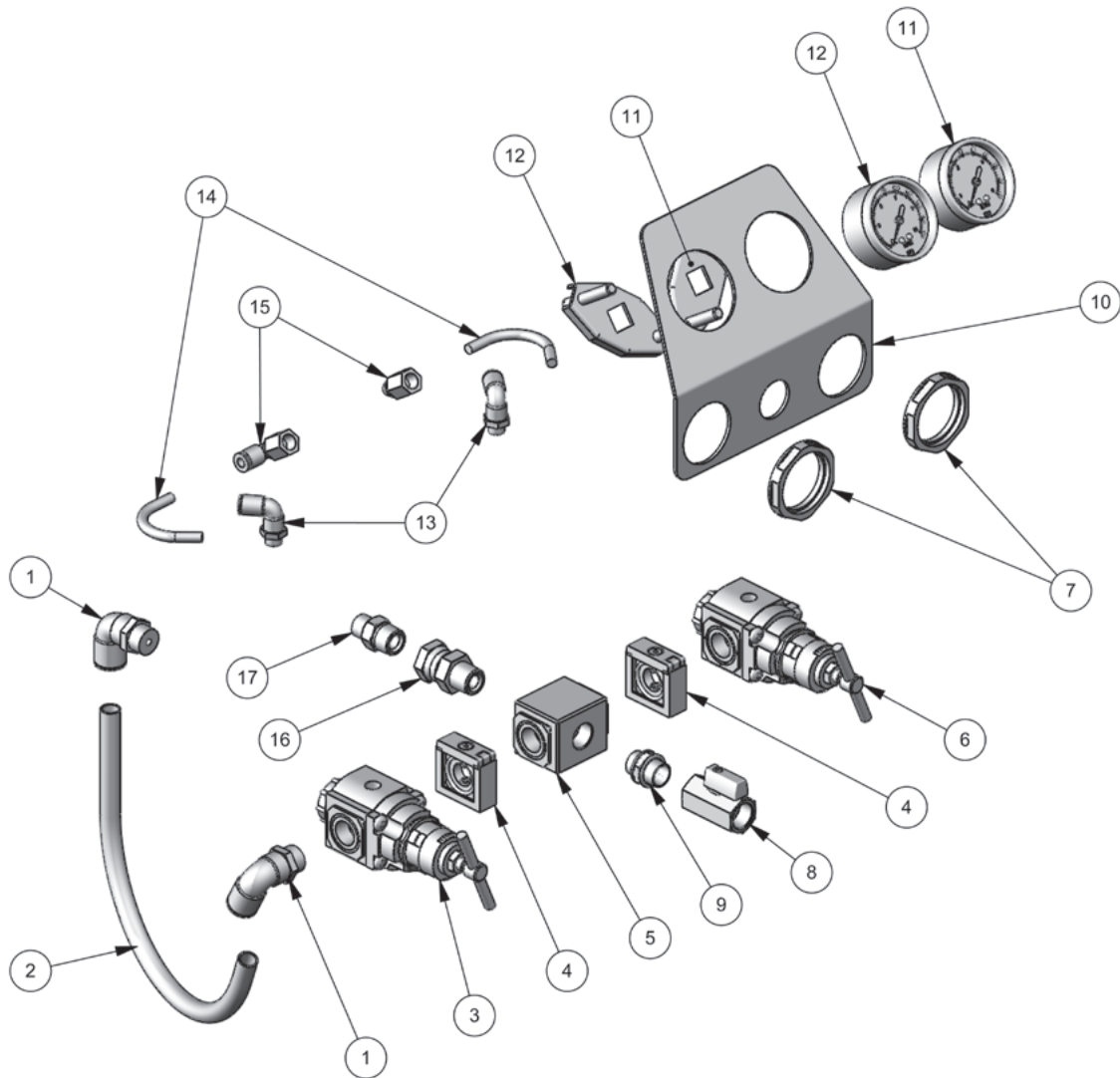

PARTS LIST

When ordering, please specify Part No.

ITEM NO.	PART NO.	DESCRIPTION	QTY.
1	0115-010181	ELBOW FITTING	2
2	0115-010185	TUBING	1
3	0115-010183	• AIR REGULATOR 0-160 PSI (0-11 BAR)	1
4	0115-010189	QUICK CLAMP	2
5	0115-010188	MANIFOLD BLOCK	1
6	0115-010182	• AIR REGULATOR 0-60 PSI (0-4 BAR)	1
7	0115-010194	PANEL MOUNT NUT	2
8	0115-010334	MINI BALL VALVE	1
9	0115-010333	DM ADAPTER	1
10	0115-010193	DUAL REGULATOR PANEL	1
11	0115-010191	PANEL MOUNT GAUGE 0-60 PSI (0-4 BAR)	1
12	0115-010192	PANEL MOUNT GAUGE 0-160 PSI (0-11 BAR)	1
13	0115-010195	90° ELBOW SWIVEL TUBE FITTING	2
14	0115-010197	TUBING	2
15	0115-010196	90° ELBOW GAUGE TUBE FITTING	2
16	0115-010324	SWIVEL FITTING, 3/8 BSPT (M) X 3/8 BSP (F)	1
17	0115-010157	AIR CONTROL MOUNTING STUD	1

• Regulator Repair Kit
(sold separately):
0115-010228

0115-010198 AIRLESS GUN AIR CONTROL ASSEMBLY

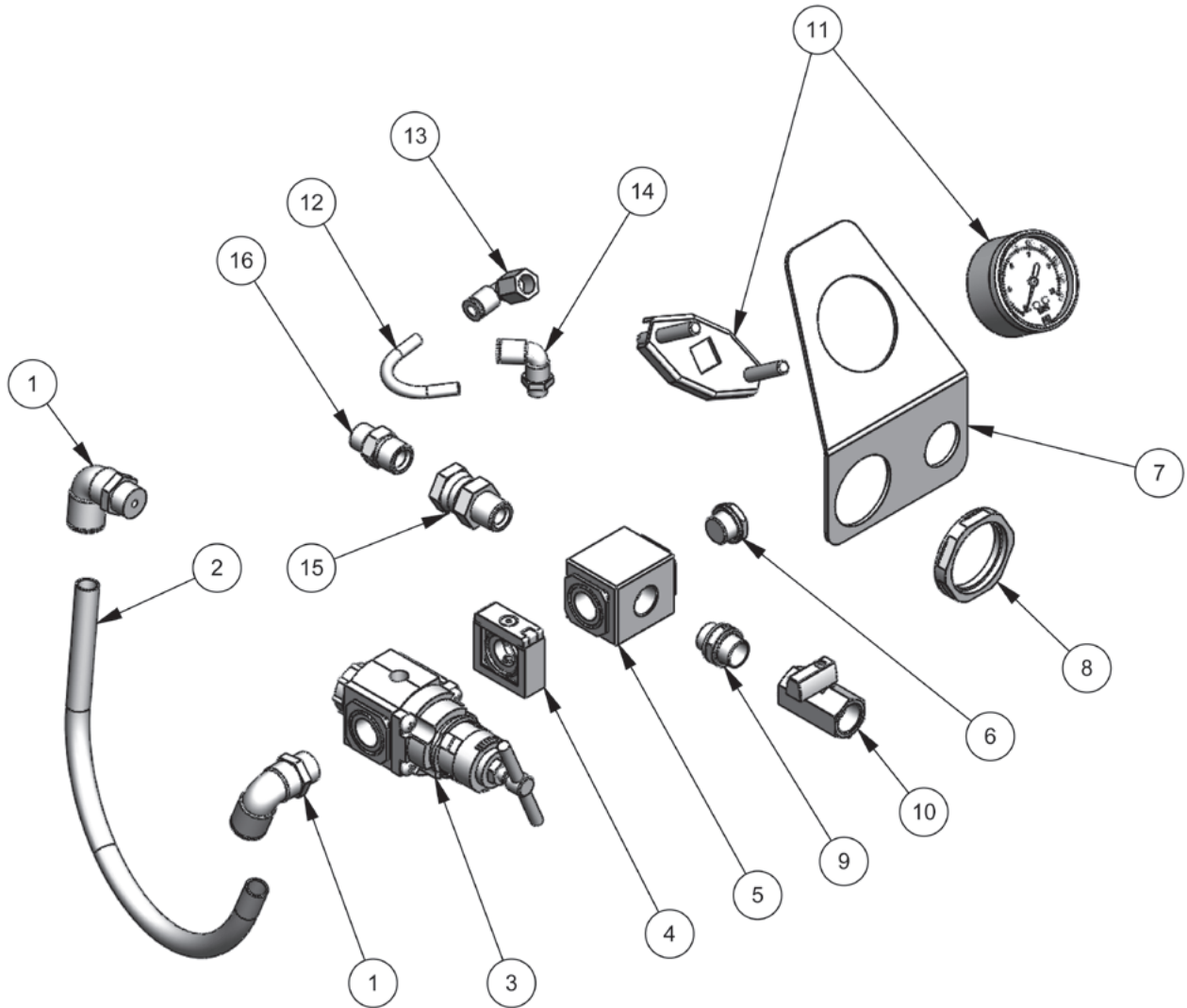

PARTS LIST

When ordering, please specify Part No.

ITEM NO.	PART NO.	DESCRIPTION	QTY.
1	0115-010181	ELBOW FITTING.....	2
2	0115-010185	TUBING	1
3	0115-010183	AIR REGULATOR 0-160 PSI (0-11 BAR).....	1
4	0115-010189	QUIK CLAMP	1
5	0115-010188	MANIFOLD BLOCK	1
6	0115-010338	PORT PLUG	1
7	0115-010199	SINGLE REGULATOR PANEL.....	1
8	0115-010194	PANEL MOUNT NUT.....	1
9	0115-010334	MINI BALL VALVE.....	1
10	0115-010333	DM ADAPTER	1
11	0115-010192	PANEL MOUNT GAUGE 0-160 PSI (0-11 BAR)....	1
12	0115-010197	TUBING	1
13	0115-010196	90° ELBOW GUAGE TUBE FITTING	1
14	0115-010195	90°ELBOW SWIVEL TUBE FITTING.....	1
15	0115-010324	SWIVEL FITTING, 3/8 BSPT (M) X 3/8 BSP (F)	1
16	0115-010157	AIR CONTROL MOUNTING STUD	1

• Regulator Repair Kit
(sold separately):
0115-010228

SYSTEM ACCESSORIES

0115-010186 CART ASSEMBLY

PARTS LIST

When ordering, please specify Part No.

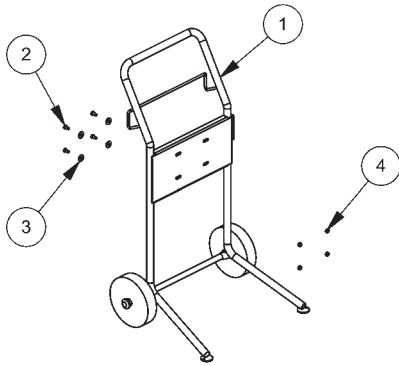

ITEM NO.	PART NO.	DESCRIPTION	QTY.
1	0114-014640	CART FRAME, WITH WHEELS	1
2	0114-014216	CAP SCREW.....	4
3	0114-014165	FLAT WASHER.....	4
4	0114-014164	HEX NUT	4

0115-010236 SUCTION HOSE ASSEMBLY

PARTS LIST

When ordering, please specify Part No.

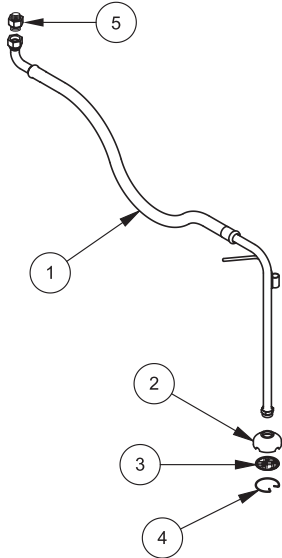

ITEM NO.	PART NO.	DESCRIPTION	QTY.
1	0114-018506	SUCTION HOSE (DN20)	1
2	0114-013734	FILTER HOUSING.....	1
3	0114-014112	STRAINER (20 MESH).....	1
4	0114-014080	RETAINING RING.....	1
5	0111-010235	REDUCING NIPPLE	1
6	0114-016024	ADAPTER (NOT SHOWN)	1

ADDITIONAL STRAINERS AVAILABLE (sold separately):
 0114-014068 (50 mesh)
 0114-014221 (70 mesh)

ACCESSORIES FOR YOUR MX1212 PUMP

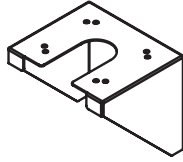

WALL BRACKET
0115-010179

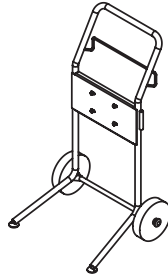

TROLLEY ASSEMBLY
0115-010186

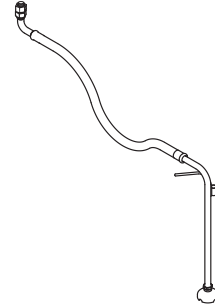

SUCTION HOSE ASSEMBLY
0115-010236 20 L (20 MESH)
0115-010381 200 L (30 MESH)



LUBRICATING OIL FOR
FLUID PUMP
0114-009433 (Solvent Based Materials)
0114-014871 (Water Based Materials)

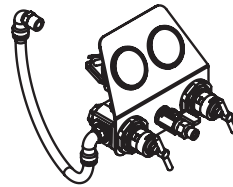

AIR CONTROLS
0115-010180 (Air Assist)
0115-010198 (Airless)



FLUID FILTER (100 MESH)
0110-009130

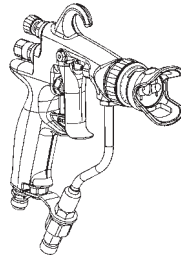

AA4400M AIR ASSIST SPRAY GUN

FLAT TIP VERSIONS:

0909-4400-HF0000
(HVLP, no tip included)

0909-4400-LF0000
(Trans-Tech, no tip included)

TWIST TIP VERSIONS:

0909-4400-HT0000
(HVLP, no tip included)

0909-4400-LT0000
(Trans-Tech, no tip included)

NOTES

WARRANTY

This product is covered by Binks' 5 Year Limited Warranty.

Binks European Sales and Service Listing: www.itwifeuro.com

ITW Industrial Finishing

Binks has authorized distributors throughout the world. For technical assistance or the distributor nearest you, see listing below.

ITW Industrial Finishing:

Ringwood Road, Bournemouth
BH11 9LH England
Tel: +44(0) 1202 571111 Fax: +44(0) 1202 573488
Email: industrial.mktg@itwfinishing.co.uk

ITW Surfaces et Finitions:

163-171 Av des Auréals
26014 Valence cedex France
Tel: +33 4 75 75 27 00 Fax: +33 4 75 75 27 59
Email: mkt@itwsf.com

ITW Oberflächentechnik GmbH:

Justus-von-Liebig-Straße 31
D-63128 Dietzenbach Germany
Tel: +49 (0) 6074-403-1 Fax: +49 (0) 6074-403-300
Email: marketing@itw-finishing.de



www.itwifeuro.com

2/10 ©2010 ITW Industrial Finishing All rights reserved. Printed in U.S.A.

77-2906R-1-EU